



Multi-functional Flow Control Valve for Water Treatment Systems

83602 (Old Model No.: F79A)

83602B (Old Model No.: F79B)

83504/83604 (Old Model No.: F82A1/F82A3)

83504AB/83604AB (Old Model No.: F82AG1/F82AG3)

83504B/83604B (Old Model No.: F82B1/F82B3)

83504BB/83604BB (Old Model No.: F82BG1/F82BG3)

User Manual

Please read this manual in details
before using this valve and keep it properly
in order to consult in the future.

0WRX.466.514

WENZHOU RUNXIN MANUFACTURING MACHINE CO.,LTD

ADD: NO.169, RUNXIN ROAD, SHANFU TOWN, WENZHOU, ZHEJIANG, CHINA.

TEL.:0086-577-88630038, 88576512, 85956057 FAX:0086-577-88633258

E-MAIL: sales@run-xin.com <http://www.run-xin.com>

Rev.A.2209



Fast Rinse Time		10min.	0~99:59	Fast rinse time (minute)
Maximum Interval Regeneration Days	H-30	30	0~40	Regenerate at the regeneration time even though the available volume of treated water does not drop to zero (0).
Output Control Mode	b-01	01	01 or 02	b-01: Signal turn on when start of regeneration and shut off at the end of regeneration. (Connection refers to the Figures on page 6) b-02: Signal available only in intervals of each status. (Connection refers to the Figures on page 6)

B. Process Display

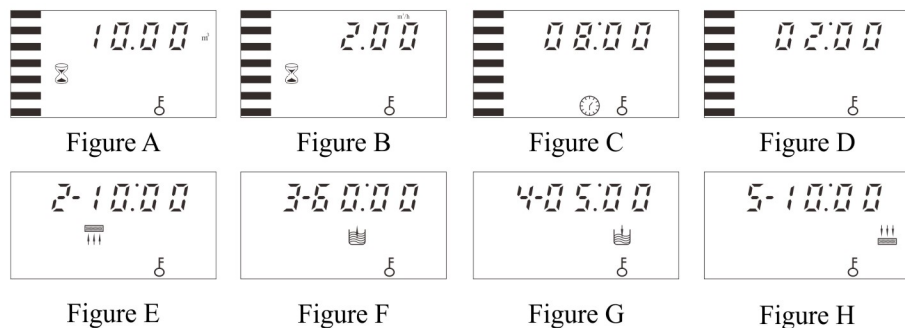

Illustration:

- In Service status, the figure shows A/B/C/D; In Backwash status, it shows figure E/C; In Brine & Slow Rinse status, it shows F/C; In Brine Refill status, it shows figure G/C; In Fast Rinse status, it shows figure H/C. In each status, every figure shows 15 seconds.
- Above displays are taking the meter type A-01 for example. For the time clock type, it shows the rest days or hours, such as 1-03D or 1-10H.
- The display screen will only show "-00-" when the electrical motor is running.
- The time of day figure "🕒" flashes continuously, such as "12:12" flashes, indicates long outage of power. It reminds to reset the time of day.
- The display will show the error code, such as "-E1-" when the system is in error.
- Working process: Service → Backwash → Brine & Slow Rinse → Brine Refill → Fast Rinse → Service

C. Usage

After being accomplished installation, parameter setting and trial running by professional, the valve could be put into use. In order to ensure the quality of outlet water can reach the requirement, the user should complete the below works:

- ① Ensure that there is solid salt all the time in the brine tank in the course of using when this valve is used for softening. The brine tank should be added crystalline coarse salt only, at least 99.5% pure, forbidding use small salt and iodized salt.
- ② Test the hardness of outlet water and raw water at regular time. When the outlet water hardness is unqualified, please press the and the valve will temporarily regenerate again (It will not affect the original set operation cycle.)
- ③ When the raw water hardness changes a lot, you can adjust the water treatment capacity as follow:

Press and hold both and for 5 seconds to unlock the buttons. Press , and the lights on, then press , the digital area shows the control mode. If it shows A-02 or A-12, press three times, and the digital area will show the set water treatment capacity (If the control mode shows A-03 or A-13, then press four times, the digital area will show the raw water hardness); Press again, and digital flash. Press or continuously, adjust the capacity value (Or water hardness). Press and hear a sound "Di", then finish the adjustment. Press to exit and turn back the service status.

For the estimation of water treatment capacity, you can refer to the professional application specification. When selecting A-03 or A-13 intelligent control mode, the controller will automatically calculate the water treatment capacity by setting raw water hardness, resin volume, and regeneration factor.

- ④ For A-01, A-03, A-11 or A-13 control mode (Delayed regeneration type), please pay attention to whether the time is current or not. If the time is not right, you can adjust it as below: After unlocking the buttons, press , the and light on. Then press , the and hour value flash. Press or continuously, adjust the hour value; Press again, and minute value flash. Press or continuously, adjust the minute value; Press and hear a sound "Di", then finish the adjustment. Press exit and turn back to the service status.

The regeneration parameters have been set when control valve left the factory. Generally, it does not need to reset. If you want to inquire and modify the setting, you can refer to the professional application specification.

3. Applications

3.1 Softener Flow Chart (Take F79A as example, for F79B, the entire regeneration cycle has raw water passing).

Working Process and Principle

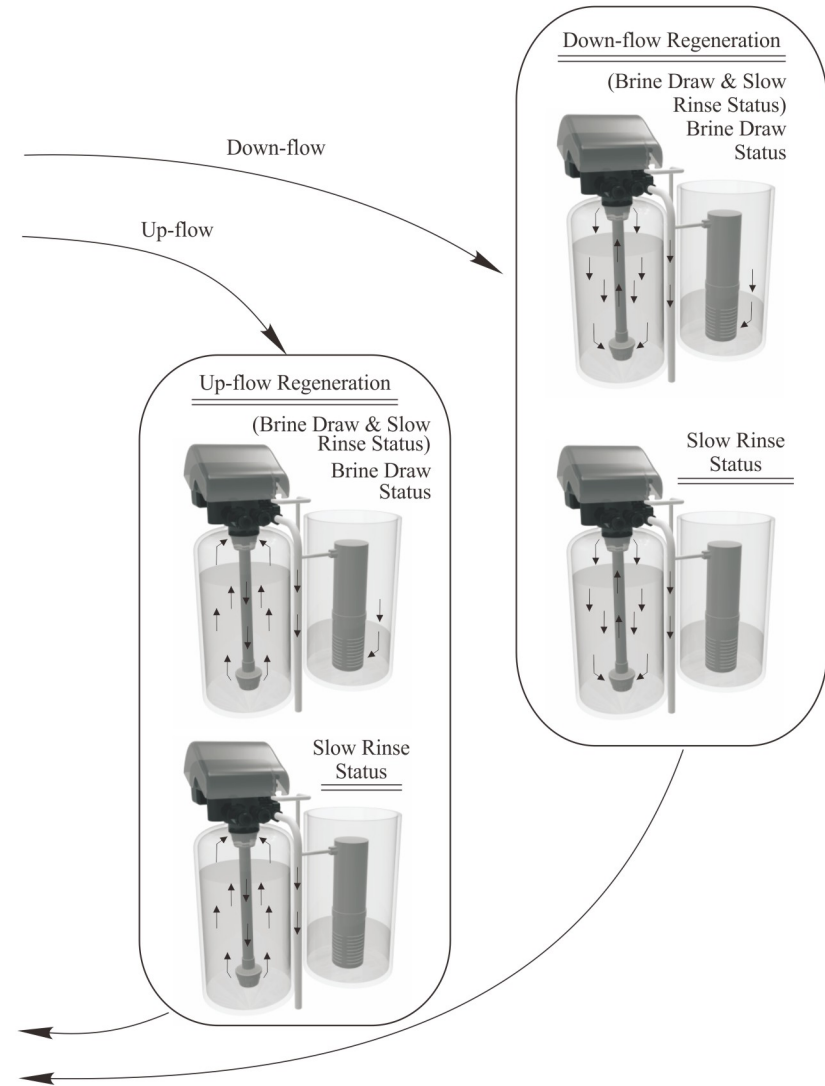
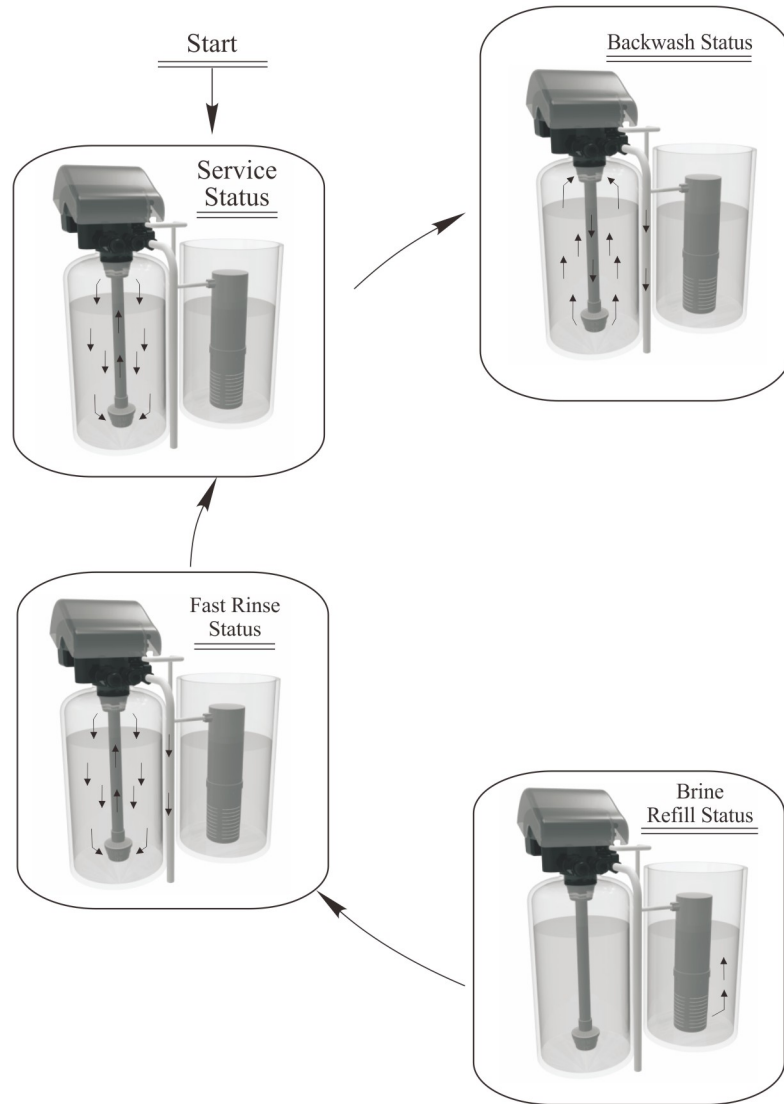

3.2 The Function and Connection of PC Board

Open the front cover of control valve, you will see the main control board and connectors as below:

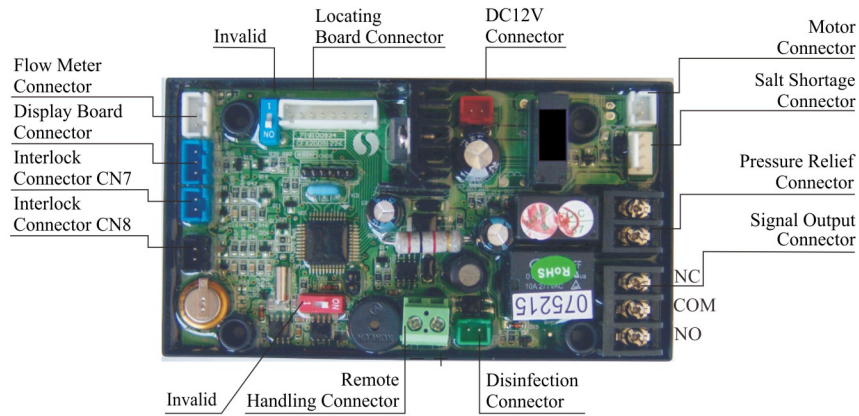

The main functions on main control board:

Function	Application	Explanation
Signal output connector b-01	Outlet solenoid valve	Used in strict requirements regarding no hard water flowing from outlet or controlling the liquid level controller in water tank.
	Inlet pump	Increase pressure for regeneration or washing. Use the liquid level controller to control inlet pump to ensure there is water in tank.
Signal output connector b-02	Inlet solenoid valve or inlet pump	When inlet pressure is high, it needs to close water inlet to protect motor when valve is rotating.
Pressure relief connector	Control the inlet bypass to release pressure.	Used for pump water supply. When valve is rotating, pressure relief connector opened to prevent pressure increasing rapidly.
Interlock connector	To ensure not only one control valve regeneration or washing in system.	Use in RO pre-treatment, water supply together but regeneration in turn, second grade ion exchange equipment, etc.
Remote handling connector	Receipt signal to make the control valve rotate to next status.	It is used for on-line inspection system, connected with PC to realize automatically or remote controlling valve.

A. Signal Output Connector

1) Control Outlet Solenoid Valve (Set b-01)

① Solenoid Valve on Outlet Controls the Water Level in Brine Tank.

Instruction: If system requires no hard water flowing from outlet in regeneration cycle (Mainly for no hard water flows out when valve is switching or valve in backwash or brine drawing status), a solenoid valve could be installed on outlet, the wiring refers to Figure 3-1.

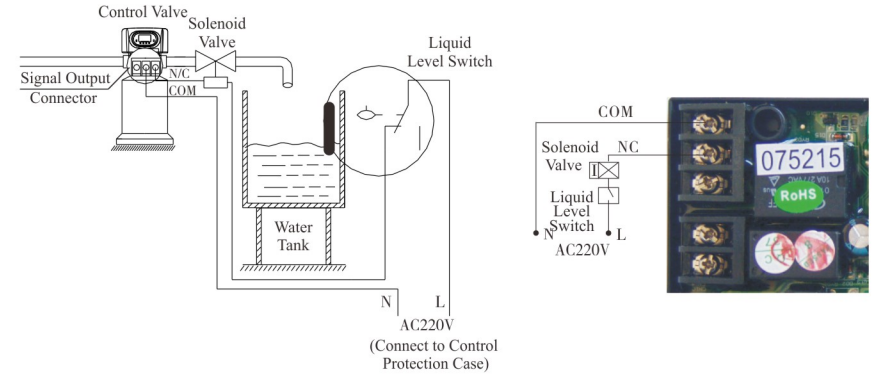

Figure 3-1 Wiring of Solenoid Valve on Outlet

Function:

When valve is in service status, if soft water tank is short of water, solenoid valve will open to supply soft water, but if soft water tank has enough water, solenoid valve will close, so no soft water supplied into soft water tank.

When the valve is in backwash or other regeneration status, there is no signal output. So, solenoid valve will close, and no raw water flows into soft water tank.

② Control Inlet Solenoid Valve (Set b-02)

Instruction: When inlet pressure exceeds 0.6MPa, install a solenoid valve on inlet. Control mode is b-02. Pressure is relieved when valve switching, the wiring refers to Figure 3-2. As Figure 3-3 shows, it also can use the pressure relief connector to work.

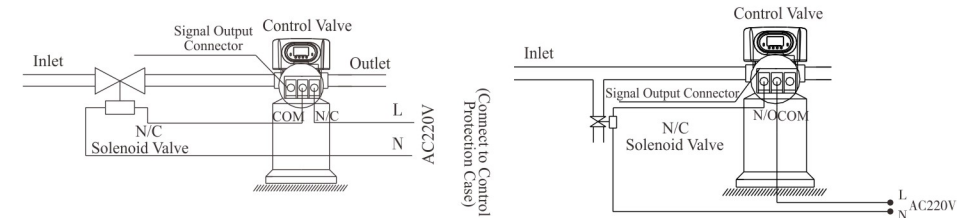

Figure 3-2 Wiring of Solenoid Valve on Inlet

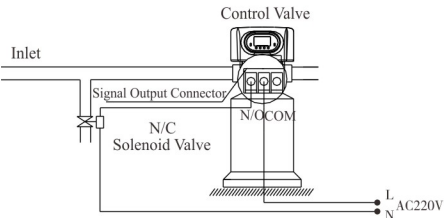

Figure 3-3 Wiring of Pressure Relief Port

Function:

When inlet pressure is high, install a solenoid valve on inlet to ensure valve switching properly. When valve is exactly in the status of Service, Backwash, Brine& Slow Rinse, Brine Refill and Fast Rinse, solenoid valve is open. When valve is switching, solenoid valve is closed, no water flows into valve to ensure valve switching properly. It could prevent the problem of mixing water and water hammer.

Use interlock cable to realize valves in parallel and series in same system which is suited for RO pre-treatment system or second grade Na⁺ system. The wiring refers to Figure 3-4:

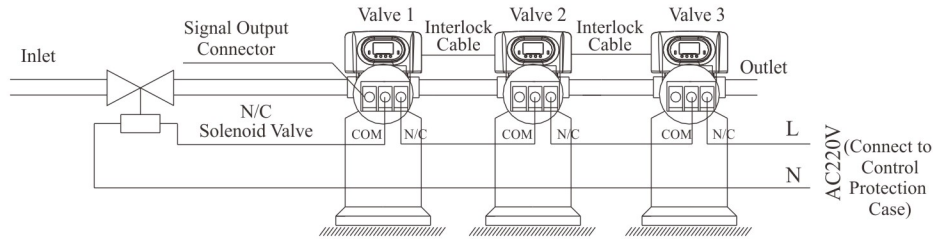

Figure 3-4 Wiring of Inlet Water Solenoid Valve in Multi-stage Series

2) Liquid Level Controller Controls Inlet Pump (Two-phase motor) (Set b-01)

Instruction: For the system using well or middle-tank supplying water, switch of liquid level controller and valve together control pump opening or closing. The wiring refers to Figure 3-5:

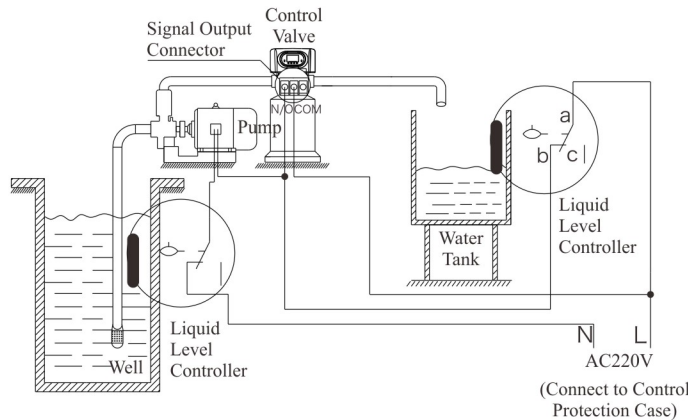

Figure 3-5 Wiring of Liquid Level Controller Controlling Inlet Pump

Function:

When the valve is in service status, if water tank is short of water, pump starts working; if not, the switch of liquid level controller is closed, so pump doesn't work.

When valve is in backwash or other regeneration status, no matter what is water condition in water tank, open the pump to make sure there is water on inlet. As there is no water flows out of outlet in regeneration cycle, it ensures no water fill into brine tank. A liquid level controller at the top opening of well or in middle water tank in RO system can protect pump from working without water in case of out of raw water.

3) Liquid Level Controller in Water Tank Controls Inlet Pump (Three-phase, refers Figure 3-6) (Set b-01)

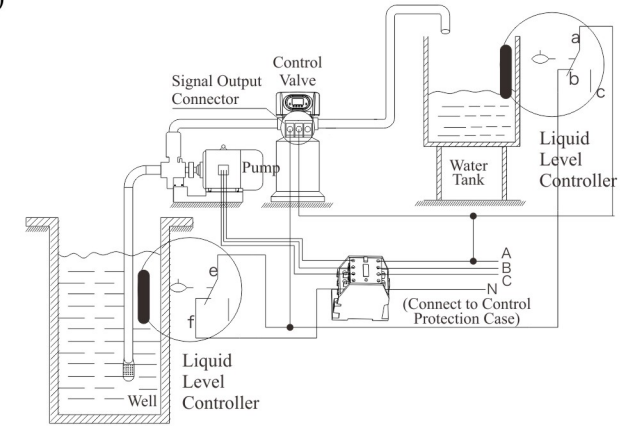

Figure3-6 Wiring of Liquid Level Controller in Water Tank Controls Inlet Pump

4) Control Inlet Booster Pump (Set b-01 or b-02)

Instruction: If inlet water pressure is less than 0.15MPa, which makes backwash or rinse drawing difficult, a booster pump is suggested to be installed on inlet. Control mode b-01. When system in regeneration cycle, booster pump is open, the wiring refers to Figure 3-7. If the booster pump current is bigger than 5A, the system needs to install a contactor, the wiring refers to Figure 3-8.

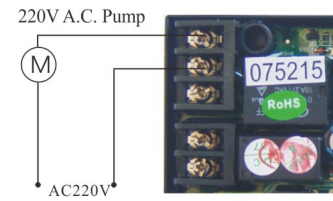

Figure 3-7 Wiring of Booster Pump on Inlet

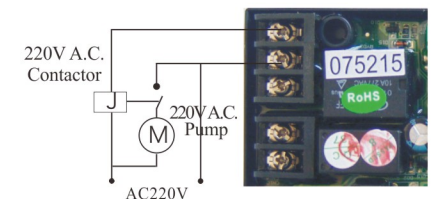

Figure 3-8 Wiring of Booster Pump on Inlet

B. Interlock

Instruction: In the parallel water treatment system, it ensures only one valve in regeneration or washing status and (n-1) valves in service, that is, realizing the function of supplying water simultaneously and regenerating individually.

In the series-water treatment system (Second grade Na⁺ Exchanger or RO pre-treatment system), it ensures only one valve in regeneration or washing status and there is/are water(s) in service. The wiring refers to Figure 3-9:

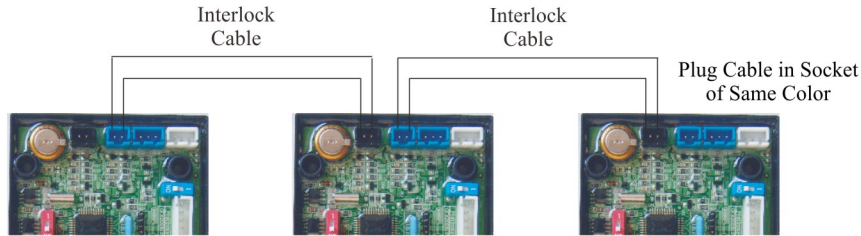

Figure 3-9 Wiring of Interlock Cable

Use interlock cable to connect the black socket of one valve with the blue socket of another valve in series.

One system with several valves, if interlock cable is disconnected, the system is divided into two individual system.

C. Pressure Relief Output

In adopt inlet booster pump or well water supply systems, valve switching will increase the system water feeding pressure, the motor can't rotate. Installing the solenoid valve in the inlet pipeline, connecting with the drain. When the valve switching, the pressure relief solenoid valve opens, the water flows to the drain. Avoiding the system closed, which will cause the inlet pressure rising too fast to damage the valve. The wiring refers to Figure 3-10.

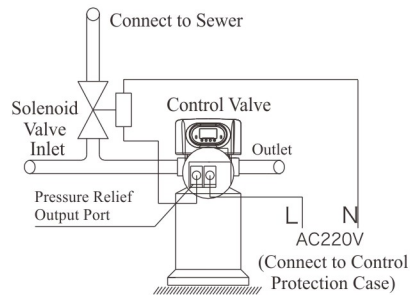

Figure 3-10 Wiring of Pressure Relief Output Connector

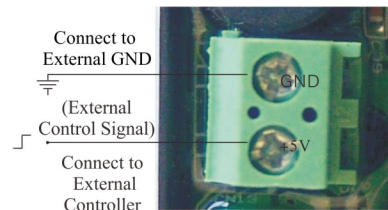

Figure 3-11 Wiring of Remote Handling Connector

D. Remote Handling Connector

When the valve is used to make pure water or other system that can be monitored online or connected to a PC, etc., when the conductivity or other parameters reach the set value or the PC sends a signal and needs system regeneration, it can provide a signal to remote handling connector of main control board by the signal line, which can make the valve regenerate immediately. The connector receiving the signal is equivalent to pressing the manual button. The wiring refers to Figure 3-11:

E. Interlock System

2 or more than 2 valves are interlocked connecting in one system and all valves are in service but regenerate individually. The wiring refers to Figure 3-12:

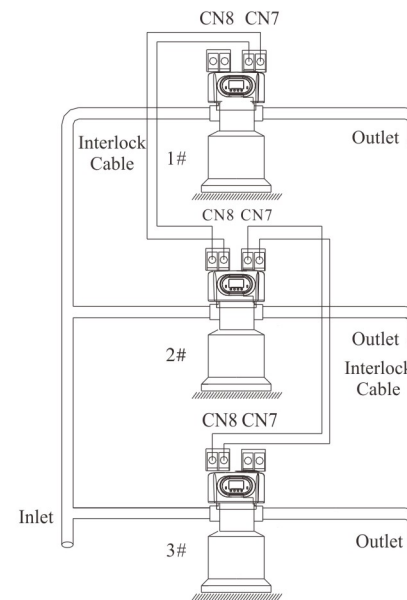

Figure 3-12 Interlock system

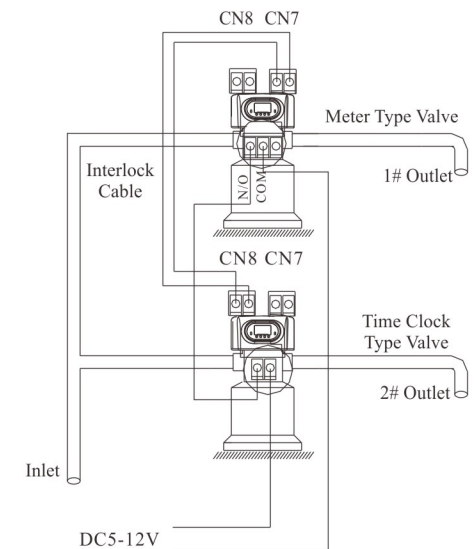

Figure 3-13 Series system

F. Series System

This is a 2 or more than 2 valves system, all in service, with one flow meter for the entire system. For the time type valve, the regeneration time should be set and adjusted to the Max; for the meter type valve, connect its signal output connector with the remote handling connector of the time clock type valve. That can realize the function of supplying water simultaneously and regenerating orderly. The wiring refers to Figure 3-13:

3.3 System Configuration and Flow Rate Curve

A. Product Configuration

Product configuration with tank, resin volume, brine tank and injector

Tank Size (mm)	Resin Volume (L)	Flow Rate (t/h)	Brine Tank Size (mm)	Minimum Salt Consumption for Regeneration (Kg)	Injector Model (Old/New)
φ 180 × 1130	16	0.5	φ 250 × 520	2.4	6302/6801
φ 205 × 1300	25	0.7	φ 390 × 810	4.0	6303/6802
φ 255 × 1390	40	1.2	φ 390 × 810	6.0	6305/6804
φ 300 × 1650	60	1.8	φ 450 × 940	9.0	6306/6806
φ 355 × 1650	100	2.5	φ 500 × 1060	15.0	6308/6808
φ 400 × 1650	120	3.5	φ 550 × 1160	18.0	6309/6809
φ 450 × 1650	150	4.5	φ 550 × 1160	22.5	6310/6810

Note: ① The flow rate calculation is based on linear velocity 25m/h; the minimum salt consumption for regeneration calculation is based on salt consumption 150g / L (Resin).

② The above configuration is applicable to industrial sodium ion exchanger, and the specifications and parameters are for reference only.

B. Flow Rate Characteristic

1). Pressure-flow rate curve

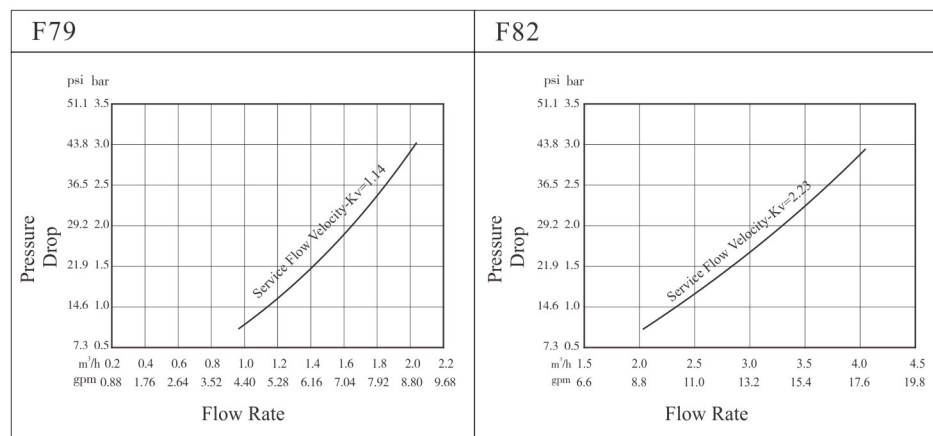

2). Injector Parameter Table

Old Injector: (6300 series)

Inlet Pressure MPa	Draw Rate (L/M)									
	6301 Coffee	6302 Pink	6303 Yellow	6304 Blue	6305 White	6306 Black	6307 Purple	6308 Red	6309 Green	6310 Orange
0.15	0.81	1.12	1.58	2.21	2.45	3.30	3.44	4.08	5.19	5.69
0.20	0.95	1.41	1.87	2.53	2.89	3.88	4.21	4.83	5.36	6.80
0.25	0.99	1.61	2.08	2.79	3.30	4.30	4.66	5.39	6.86	7.65
0.30	1.30	1.81	2.18	3.05	3.66	4.74	5.15	5.95	7.50	8.60
0.35	1.45	1.96	2.39	3.27	3.94	5.02	5.55	6.51	8.30	9.57
0.40	1.56	2.12	2.55	3.50	4.25	5.41	5.88	6.77	8.74	9.90

New Injector: (6800 series)

Inlet Pressure MPa	Draw Rate/Slow Rinse Rate (L/M)											
	6820 Grey	6821 Cyan	6801 Coffee	6802 Pink	6803 Yellow	6804 Blue	6805 White	6806 Black	6807 Purple	6808 Red	6809 Green	6810 Orange
0.15	0.61/ 0.48	0.88/ 0.63	1.30/ 0.76	1.45/ 1.17	2.00/ 1.65	2.68/ 2.28	2.72/ 2.67	3.72/ 3.11	4.52/ 3.55	4.85/ 3.86	5.75/ 4.71	6.00/ 4.78
0.20	0.70/ 0.56	1.03/ 0.74	1.52/ 0.87	1.73/ 1.38	2.37/ 1.84	3.16/ 2.54	3.27/ 2.93	4.27/ 3.40	5.03/ 3.81	5.70/ 4.25	6.40/ 5.15	6.26/ 5.41
0.25	0.79/ 0.60	1.14/ 0.83	1.77/ 0.98	1.90/ 1.47	2.70/ 1.97	3.46/ 2.71	3.78/ 3.13	4.80/ 3.68	5.65/ 4.11	6.22/ 4.61	7.19/ 5.57	7.13/ 5.89
0.30	0.87/ 0.65	1.27/ 0.91	1.93/ 1.06	2.26/ 1.56	3.00/ 2.12	3.80/ 2.91	4.30/ 3.39	5.23/ 3.93	6.20/ 4.43	6.80/ 4.88	7.97/ 6.00	8.53/ 6.51
0.35	0.95/ 0.72	1.35/ 0.99	2.08/ 1.12	2.20/ 1.67	3.23/ 2.23	4.05/ 3.09	4.50/ 3.62	5.57/ 4.17	6.67/ 4.71	7.27/ 5.16	8.50/ 6.27	8.80/ 6.97
0.40	1.00/ 0.77	1.43/ 1.05	2.23/ 1.14	2.27/ 1.75	3.46/ 2.35	4.38/ 3.24	4.88/ 3.78	5.95/ 4.35	6.95/ 4.99	7.63/ 5.41	8.80/ 6.66	9.30/ 7.28

3). Configuration for Standard Injector and Drain Line Flow Control

Old Injector: (6300 series)

Tank Dia. mm	Injector Model	Injector Color	Draw Rate	Slow Rinse Rate	Brine Refill Rate	DLFC	Backwash/ Fast Rinse Rate
			L/m	L/m	L/m		L/m
150	6301	Coffee	1.30	0.91	3.00	1#	4.70
175	6302	Pink	1.81	1.32	3.70	1#	4.70
200	6303	Yellow	2.18	1.73	3.80	2#	8.00

MODEL: 83602-F79A3/83602B-F79B/83604-F82A3/83604B-F82B3

225	6304	Blue	3.05	2.14	3.30	2#	8.00
250	6305	White	3.66	2.81	4.30	3#	14.40
300	6306	Black	4.74	3.32	4.20	3#	14.40
325	6307	Purple	5.15	3.55	4.10	4#	22.80
350	6308	Red	5.95	4.00	4.00	4#	22.80
400	6309	Green	7.50	5.13	4.00	5#	26.40
450	6310	Orange	8.60	5.98	3.90	5#	26.40

New Injector: (6800 series)

Tank Dia. (mm)	Regeneration Way	Injector Code	Nozzle/Throat Type	Nozzle/Throat/Plug Color	BLFC Code		DLFC Code
					Standard	Optional	
150	Down-flow	5468237	6821	Cyan	8468057	8468076, 8468075	8468064
	Up-flow	5468247	6820	Grey			
175	Down-flow	5468238	6801	Coffee	8468057	8468076, 8468075	8468043
	Up-flow	5468248	6821	Cyan			
200	Down-flow	5468239	6802	Pink	8468056	8468076, 8468075, 8468057	8468042
	Up-flow	5468249	6821	Cyan			
225	Down-flow	5468240	6803	Yellow	8468056	8468076, 8468075, 8468057	8468060
	Up-flow	5468250	6801	Coffee			
250	Down-flow	5468241	6804	Blue	8468052	8468076, 8468075, 8468057, 8468056	8468061
	Up-flow	5468251	6802	Pink			
300	Down-flow	5468242	6806	Black	8468053	8468076, 8468075, 8468057, 8468056, 8468052	8468077
	Up-flow	5468252	6803	Yellow			
325	Down-flow	5468243	6807	Purple	8468053	8468076, 8468075, 8468057, 8468056, 8468052	8468044
	Up-flow	5468253	6804	Blue			
350	Down-flow	5468244	6808	Red	8468054	8468076, 8468075, 8468057, 8468056, 8468052, 8468053	8468062
	Up-flow	5468254	6805	White			
400	Down-flow	5468245	6809	Green	8468055	8468076, 8468075, 8468057, 8468056, 8468052, 8468053, 8468054	8468063
	Up-flow	5468255	6806	Black			
450	Down-flow	5468246	6810	Orange	8468055	8468076, 8468075, 8468057, 8468056, 8468052, 8468053, 8468054	Without DLFC
	Up-flow	5468256	6807	Purple			

MODEL: 83602-F79A3/83602B-F79B/83604-F82A3/83604B-F82B3

Note: The above configuration is suitable for industrial use. The actual configuration should be based on different raw water hardness and different water requirements. If it is used for civil and household purposes, considering the small height diameter ratio of resin bed, the optimal configuration should be selected after experimental verification, and it is recommended to use a smaller salt absorption regeneration flow rate (1~2m/h).

4). BLFC Parameter Table (Only for 6800 Injector)

Part Number	8468076	8468075	8468057	8468056	8468052	8468053	8468054	8468055	
Color	Red	Purple	Black	White	Coffee	Pink	Yellow	Blue	
Flow Rate	L/m	0.38	0.68	0.98	1.21	1.66	2.73	4.92	5.86
	gal/min	0.10	0.18	0.26	0.32	0.44	0.72	1.30	1.55

5). DLFC Parameter Table (Only for 6800 Injector)

Part Number	8468064	8468043	8468042	8468060	8468061	8468045	8468077	8468044	8468062	8468063	No DLFC	
Color	Green	Pink	Coffee	White	Black	Blue	Orange	Yellow	Purple	Red	/	
Flow Rate	L/m	3.33	4.31	7.15	7.64	10.82	15.96	18.10	18.50	24.97	30.64	32.00
	gal/min	0.88	1.14	1.89	2.02	2.86	4.22	4.78	4.89	6.60	8.10	8.45

Note: Above data for the product configurations and relevant characteristics are only for reference. When put in practice, it is subject to the different requirements of raw water hardness and application.

3.4. Parameter Settlement

①Service Time T1

Water treatment capacity:

$$Q = V_R \times K \div Y_D \text{ (m}^3\text{)}$$

- Hardness of inlet water (mmol/L)
- Exchange factor (mmol/L) 400~1000.
- Down-flow regeneration, take 400~750;
- Up-flow regeneration, take 450~1000.
- If the inlet water hardness is higher, the factor is smaller.
- Resin volume (m³)

By hours: T1=Q ÷ Q_h (Hour)

- Average water consumption per hour(m³/h)
- Water treatment capacity (m³)

By days: $T1=Q \div Q_d$ (Day)

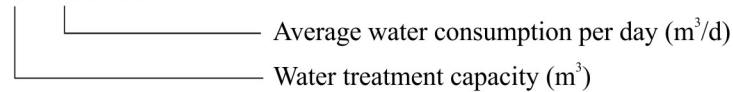

② Backwash Time T2

Generally, it is suggested to set 10~15 minutes. The higher the turbidity is, the longer backwash time can be set. However, if the turbidity is more than 5FTU, it should be better to install a filter in front of the exchanger.

③ Brine & Slow Rinse Time T3

$T3=(40\sim50) \times H_r$ (min.)

Generally, $T3=45H_r$ (min.)

In this formula, H_r —The height of resin in exchange tank (m).

④ Brine Refill Time T4

Down-flow regeneration: $T4=0.45 \times V_r \div$ Brine refill speed (min.)

Up-flow regeneration: $T4=0.34 \times V_r \div$ Brine refill speed (min.)

In this formula, V_r — Resin volume (m^3)

The brine refill speed is related to inlet water pressure. It is suggested to be 1~2 minutes longer than the calculated brine refilling time to make sure there is enough water in tank. (The brine tank should be equipped with liquid level controller)

⑤ Fast Rinse Time T5

$T5=12 \times H_r$ (min.)

Generally, the water for fast rinse is 3~6 times of resin volume. It is suggested to be 10~16 minutes. But it should meet the requirements of qualified outlet water.

⑥ Exchange Factor

Exchange factor = $E/(k \times 1000)$

In this formula, E—Resin working exchange capability (mol/m^3), it is related to the quality of resin. Down-flow regeneration, take 800~900. Up-flow regeneration, take 900~1200.

K—Security factor, always take 1.2~2. It is related to the hardness of inlet water: the higher the hardness is, the bigger the K is.

⑦ Set Up Interval Backwash Times (Only for up-flow regeneration mode)

When the turbidity of raw water is higher, the interval backwash times could be set F-00. That is to say, backwash in each regeneration; when the turbidity is lower, the interval backwash times could be set F-01 (or other number value), it is to say that backwash in every two regeneration. Thus, Service→Brine & Slow rinse→Brine refill→Fast rinse→Service→Backwash→Brine & Slow rinse→Brine refill→Fast rinse.

⑧ Regeneration Time: The whole cycle for regeneration is about two hours. According to the actual situation, please try to set up the regeneration time when you don't need to use water.

The above calculation of parameters for each step is only for reference, the actual proper time will be determined after adjusting by water exchanger supplier. This calculation procedure of softener is only for industrial application; it is not suitable for small softener in residential application.



3.5 Parameter Enquiry and Setting

3.5.1. Parameter Enquiry

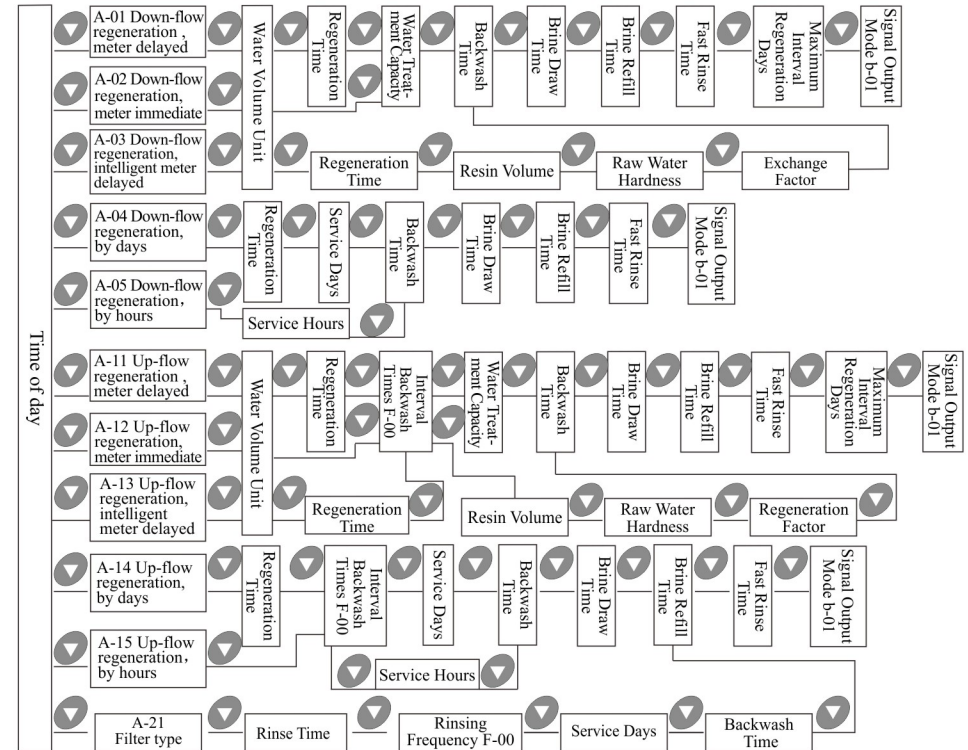





































When lights on, press and hold both and for 5 seconds to unlock the button; then press , and lights on, enter to program display mode; press or to view each value according to below process. (Press exit and turn back to service status)

















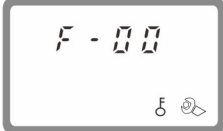













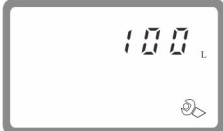











































3.5.2.Parameter Setting



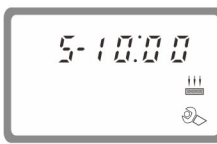

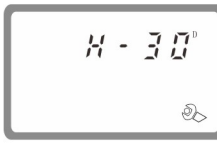

In program display mode, press  and enter into program set mode. Press  or  to adjust the value.

3.5.3. The Steps of Parameter Setting













Items	Process Steps	Symbol
Time of Day	<p>When time of day "12:12" continuously flash, it reminds to reset;</p> <p>1.Press  to enter into program display mode; both  and  light on, ":" flashes; Press , enter into set "time of day" mode, both  and hour value flash, through  or  to adjust the hour value;</p> <p>2. Press  again, both  and minute value flash, through  or  to adjust the minute value;</p> <p>3.Press  and hear a sound "Di", then finish adjustment, press  to turn back.</p>	
Control Mode	<p>1. In program display status, press  and enter into program set mode,  and 01 value flash;</p> <p>2. Press  or , set the value to be A-01/02/03/04/05/11/12/13/14/15/21 control mode;</p> <p>3. Press  and hear a sound "Di", then finish adjustment, press  to turn back.</p>	
Unit Mode	<p>1.In unit mode display status, press  and enter into program set mode,  and 01 flash;</p> <p>2.Press  or , and choose the unit from the m³/L/gal;</p> <p>3.Press  and hear a sound "Di", then finish adjustment, press  to turn back.</p>	
Regeneration Time	<p>1. In regeneration time display status, press  and enter into program set mode, shows "02:00",  and 02 flash; Press  or  to adjust the hour value.</p> <p>2. Press  again,  and 00 flash, press  or  to adjust the minute value;</p> <p>3. Press  and hear a sound "Di", then finish adjustment, press  to turn back.</p>	

Interval Backwash Times	<p>1. In Interval backwash time display status, it shows F-00. Press  and enter into program set mode.  and 00 value flash;</p> <p>2. Press  or  to adjust the interval backwash times value;</p> <p>3. Press  and hear a sound "Di", then finish adjustment, press  to turn back.</p>	
Water Treatment Capacity	<p>1. In water treatment capacity display status, it shows  and 10.00. Press  and enter into program set mode.  and 10.00 flash;</p> <p>2. Press  or  to adjust the water treatment capacity value (m³);</p> <p>3. Press  and hear a sound "Di", then finish adjustment, press  to turn back.</p>	
Resin Volume	<p>1. In resin volume display status, it shows 100L. Press  and enter into program set mode.  and 100 value flash;</p> <p>2. Press  or  to adjust the volume value (L);</p> <p>3. Press  and hear a sound "Di", then finish adjustment, press  to turn back.</p>	
Raw Water Hardness	<p>1. In raw water hardness display status, it shows yd1.2. Press  and enter into program set mode.  and 1.2 value flash;</p> <p>2. Press  or  to adjust the hardness value (mmol/L);</p> <p>3. Press  and hear a sound "Di", then finish adjustment, press  to turn back.</p>	
Exchange Factor	<p>1. In exchange factor display status, it shows AL.55. Press  and enter into program set mode.  and 55 flash;</p> <p>2. Press  or  to adjust the exchange factor value;</p> <p>3. Press  and hear a sound "Di", then finish adjustment, press  to turn back.</p>	

<p>Backwash Time</p>	<p>1. In backwash time display status, it shows  and 2-10:00. Press  and enter into program set mode.  and 10:00 flash; 2. Press  or  to adjust the backwash time; 3. Press  and hear a sound "Di", then finish adjustment, press  to turn back.</p>	
<p>Brine & Slow Rinse Time</p>	<p>1. In brine & slow rinse time display status, it shows  and 3-60:00. Press  and enter into program set mode.  and 60:00 flash; 2. Press  or  to adjust the brine time(minute); 3. Press  and hear a sound "Di", then finish adjustment, press  to turn back.</p>	
<p>Brine Refill Time</p>	<p>1. In brine refill time display status, it shows  and 4-05:00. Press  and enter into program set mode.  and 05:00 flash; 2. Press  or  to the brine refill time (minute); 3. Press  and hear a sound "Di", then finish adjustment, press  to turn back.</p>	
<p>Fast Rinse Time</p>	<p>1. In fast rinse time display status, it shows  and 5-10:00. Press  and enter into program set mode.  and 10:00 flash; 2. Press  or  to adjust the fast rinse time (minute); 3. Press  and hear a sound "Di", then finish adjustment, press  to turn back.</p>	
<p>Maximum Interval Regeneration Days</p>	<p>1. In maximum interval regeneration days display status, it shows H-30. Press  and enter into program set mode.  and 30 flash; 2. Press  or  to adjust the interval regeneration days(day); 3. Press  and hear a sound "Di", then finish adjustment, press  to turn back.</p>	



<p>Signal Output Mode</p>	<p>1. In signal output mode display status, it shows b-01. Press  and enter into program set mode.  and 01 flash; 2. Press  or  to adjust the output mode(b-02); 3. Press  and hear a sound "Di", then finish adjustment, press  to turn back.</p>	
---------------------------	--	---

For example, the fast rinse time of a softener is 12 minutes. After regenerating, the chl-
oridion in the outlet water is always higher than normal, indicating that there is not enough
time for fast rinse. If you want to set the time to 15 minutes, the modification steps as
follows:

- ① Press and hold both  and  to unlock the button. ( lights off);
- ② Press , and  lights on;
- ③ Press  or  continuously until  lights on. Then the digital area shows: 5-12M;
- ④ Press ,  and 12 flash;
- ⑤ Press  continuously until 12 changed to 15;
- ⑥ Press , there is a sound “Di” and the figure stop flashing; the program back to pro-
gram display mode;
- ⑦ If you want to adjust other parameters, you can repeat the steps from ② to ⑤; If you
don't, press  and exit from the program display mode, the display will show the current
service status.

3.6 Trial Running



After installing the multi-functional flow control valve on the resin tank with the conn-
ected pipes, as well as setting up the relevant parameters, please conduct the trail running
as follows:

- A. Close inlet/outlet valve B and Valve C, open bypass valve A, clean the impurity in the
pipe, and then close the bypass valve A. (As Figure 3 shows)
- B. Add calculated water to the brine tank and adjust the air check valve. Then add solid
salt to the brine tank and dissolve the salt as much as possible.
- C. Switch on power. Press  and enter into the backwash status; when  lights on,
slowly open the inlet valve B to 1/4 position, making the water flows into the resin tank;
you can hear the sound of air-out from the drain pipeline. After all air is out of pipeline,
then open inlet valve B completely and clean the impurity in the resin tank until the outlet
water is clean. It will take 8~10 minutes to finish the whole process.
- D. Press , and turn the status from backwash to brine & slow rinse; Enter in the process

MODEL: 83602-F79A3/83602B-F79B/83604-F82A3/83604B-F82B3

Before the valve put into use, please fill in the below content so as to help us to refer in the future.

The Program Type Setting (Operation by Professional)

When all symbols light on, press and hold  and  buttons for 5 seconds to enter the menu of valve model selection. Please set the program type in accordance with the product type.

Softener System Configuration

Tank Size: Dia. _____ mm; Height _____ mm;

Resin Volume _____ L; Brine Tank Capacity _____ L;

Hardness of Raw Water _____ mmol/L;

Pressure of Inlet Water _____ MPa;

Control Valve Model _____ ; Number _____;

The Specification of Drain Line Flow Control _____;

Injector No. _____.

Water Source: Ground-water Filtered Ground-Water Tap Water Other _____.

Parameter Set

Parameter	Unit	Factory Default	Actual Value
Control Mode A-01(02/03/04/05/11/12/13/14/15/21)	/	A-01	
Unit Mode HU-01 (A-01/02/03)	/	HU-01 (m ³)	
Regeneration Time (A-01/03/04/11/13/14/21)	/	02:00	
Rinsing Frequency (A-21)	/	F-00	
Interval Backwash Times (A-11/12/13/14/15)	/	F-00	
Water Treatment Capacity (A-01/02/11/12)	m ³	10:00	
Service Days (A-04/14/21)	D	03	
Service Hours (A-05/15)	H	20	
Resin Volume (A-03/13)	L	50	
Raw Water Hardness (A-03/13)	mmol/L	1.2mmol/L	
Regeneration Factor (A-03/13)	/	0.65	
Backwash Time	min.	10:00	
Brine & Slow Rinse Time	min.	60:00	
Brine Refill Time	min.	05:00	
Fast Rinse Time	min.	10:00	
Maximum Interval Regeneration Days (A-01/02/03/11/12/13)	D.	30	
Output Mode b-01(02)	/	b-01	

of brine & slow rinse. The air check valve will close when control valve finished sucking brine, then slow rinse starts to work. It is about 60~65 minutes for whole process.

E.Press  to brine refill status, the brine tank is being refilled with water to the required level. It takes about 5~6 minutes, then add solid salt to the brine tank.

F.Press , and turn to fast rinse status and start to fast rinse. After 10~15 minutes, take some outlet water for testing: if the water hardness reaches the requirement, and the content of chloridion in the outlet water is almost same as the inlet water, then the valve can go to the next step.

G.Press , finish brine, make the control valve return to service status and start running.

Note:

- When the control valve enters into the regeneration status, all programs can be finished automatically according to the setting time; if you want one of steps to be terminated early, you can press .

- If water inflows too fast, the media in tank will be damaged. When water inflows slowly, there is a sound of air emptying from drain pipeline.

- After changing resin, please empty air in the resin according to above Step C.

- In the process of trial running, please check the water situation in all status, ensuring there are no resin leakage.

- The time for backwash, brine& slow rinse, fast rinse and brine refill status can be set and executed according to the calculation in the formula or suggestions from the control valve suppliers.

3.7. Trouble-Shooting

A. Control Valve Fault

Problem	Cause	Correction
1. Softener fails to regenerate.	A. Electrical service has been interrupted. B. Regeneration time set incorrect. C. Controller damaged. D. Motor fails to work.	A. Assure permanent electrical service (Check fuse, plug, switch and so on). B. Reset regeneration time. C. Replace controller. D. Replace motor.
2. Regeneration time is not correct.	A. Time of day does not set correctly. B. Power failure more than 3 days.	A. Check program and reset time of day. B. Reset time of day.

Control Valve Fault (Continued)

3. Softener supply hard water.	A. Bypass valve is open or leaking. B. No salt in brine tank. C. Injector plugged. D. Insufficient water flows into brine tank. E. O-ring on riser pipe leaks. F. Interior of valve leaks. G. Regeneration cycles are not correct or raw water quality deteriorated. H. Shortage of resin. I. Bad quality of raw water or impeller blocked. J. Adjusting bolt is open.	A. Close or repair bypass valve. B. Make sure there is solid salt in the brine tank. C. Change or clean injector. D. Check brine tank refill time. E. Make sure riser pipe is not cracked. Check o-ring and tube pilot. F. Check and repair valve body. G. Set correct regeneration time or water capacity. H. Add resin to resin tank and check whether resin leaks. I. Reduce the inlet turbidity, clean or replace flow meter. J. Close the adjusting bolt.
4. Softener fails to draw brine.	A. Inlet pressure is too low. B. Brine line plugged. C. Brine line leaks. D. Injector plugged or damaged. E. Interior of valve leaks. F. Drain line plugged. G. Sizes of injector and DLFC are not matched with tank.	A. Increase inlet pressure. B. Check and clean brine line. C. Check brine line. D. Clean or replace injector. E. Repair or replace valve body. F. Clean drain line. G. Select correct injector and DLFC according to the instruction requirements.
5. Unit used too much salt.	A. Improper salt setting. B. Excessive water in brine tank.	A. Check salt usage and salt setting. B. See problem no.6.
6. Excessive water in brine tank.	A. Overlong brine refill time. B. Excess water left after brine draw. C. Foreign material in brine valve. D. Not install liquid level controller and power failure in brine status. E. Brine refill is uncontrolled.	A. Reset correct brine refill time. B. Check the injector and make sure no stuff in the brine pipe. C. Clean liquid level controller and brine line. D. Stop water supplying and restart or installs liquid level controller in salt tank when power restored. E. Repair or replace liquid level controller.

Control Valve Fault (Continued)

7. Pressure lost or the pipe rusted.	A. Iron scale in the water supply pipe. B. Iron scale accumulated in the softener. C. Fouled resin bed. D. Too much iron in the raw water.	A. Clean the water supply pipe. B. Clean valve and add resin cleaning chemical, increase frequency of regeneration. C. Check backwash, brine draw and brine tank refill. Increase frequency of regeneration and backwash time. D. Iron removal equipment is required to install before softening.
8. Resin discharged through drain pipe	A. Air in water system. B. Strainer is broken. C. Large drain flow rate when backwash.	A. Empty the air from the system. B. Replace new strainer. C. Check and adjust proper drain rate.
9. Control valve cycle continuously.	A. Locating signal wire breakdown. B. Controller is faulty. C. Foreign material stuck the driving gear. D. Time of regeneration steps were set to zero.	A. Check and connect locating signal wire. B. Replace controller. C. Take out foreign material. D. Check program setting and reset.
10. Drain flows continuously.	A. Interior of valve leaks. B. Power off when in back wash or fast rinse.	A. Check and repair valve body or replace it. B. Adjust valve to service status or turn off bypass valve and restart when electricity supply.
11. Interrupted or irregular brine draw.	A. Water pressure is too low or not stable. B. Injector is plugged or damaged. C. Air in resin tank. D. Floccules in resin tank during up-flow regeneration.	A. Increase water pressure. B. Clean or replace injector. C. Check and find the reason. D. Clean the floccules in resin tank.
12. Water flows out from drain or brine pipe after regeneration.	A. Foreign material in valve which makes valve can't be closed completely. B. Hard water mixed in valve body. C. Water pressure is too high which results in valve not getting the right status.	A. Clean foreign material in valve body. B. Change valve core or sealing ring. C. Reduce water pressure or use pressure release function.

Control Valve Fault (Continued)

13. Salt water in outflow pipe.	A. Foreign material in injector or injector fails to work. B. Brine valve can't be shut-off. C. Fast rinse time is too short.	A. Clean and repair injector. B. Repair brine valve and clean it. C. Extend fast rinse time.
14. Water capacity decreases.	A. Regenerate not properly. B. Fouled resin bed. C. Salt setting is not proper. D. Softener setting is not proper. E. Raw water quality deteriorated. F. Impeller has already gotten stuck.	A. Regenerate according to the right way. B. Increase backwash flow rate and times, clean or change resin. C. Reset the appropriate amount of salt. D. According to the test of outlet water, recount and reset. E. Regenerate by manual temporarily, then reset regeneration cycle. F. Disassemble flow meter and clean it, or replace it with a new flow meter.

B. Controller Fault

Problem	Cause	Correction
1. All indicators display on display board.	A. Wiring of display board with control board fails to work. B. Control board is damaged. C. Transformer damaged. D. Electrical service is not stable.	A. Check and replace the wiring. B. Replace control board. C. Check and replace transformer. D. Check and adjust electrical service.
2. No display on display board.	A. Wiring of display board with control board fails to work. B. Display board damaged. C. Control board damaged. D. Electricity is interrupted.	A. Check and replace wiring. B. Replace display board. C. Replace control board. D. Check electricity.
3. E1 flashes	A. Wiring of locating board with control board fails to work. B. Locating board damaged. C. Mechanical driven failure. D. Control board damaged. E. Wiring of motor with control board is fault. F. Motor damaged.	A. Replace wiring. B. Replace locating board. C. Check and repair mechanical part. D. Replace control board. E. Replace wiring. F. Replace motor.
4. E2 flashes	A. Hall component on locating board damaged. B. Wiring of locating board with control board fails to work. C. Control board damaged.	A. Replace locating board. B. Replace wiring. C. Replace control board.

5. E3 or E4 flashes	A. Control board damaged.	A. Replace control board.
---------------------	---------------------------	---------------------------

3.8. Assembly & Parts

F79A Valve Body Assembly

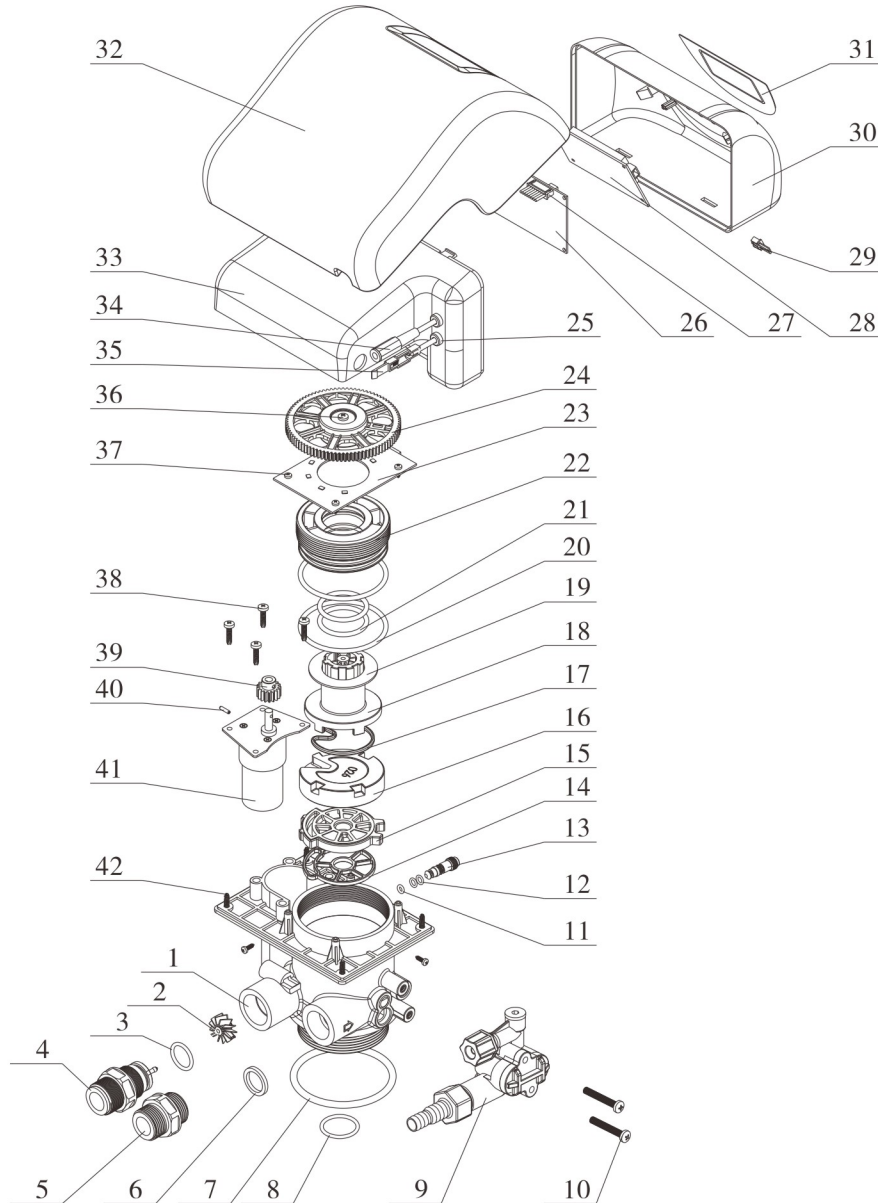

F79A Valve Body Components.

Item	Description	Part No.	Quantity	Item	Description	Part No.	Quantity
1	Valve Body	5022029	1	22	Fitting Nut	8092011	1
2	Impeller	5436007	1	23	Locating Board	6380011	1
3	O-ring	8378075	1	24	Gear	5241009	1
4	Flow Meter Connector	8458026	1	25	Cable Clip	8126004	2
5	Connector	8458011	1	26	Control Board	6382021	1
6	Seal Ring	8371019	1	27	Wire for Locating Board	5511004	1
7	O-ring	8378160	1	28	Display Board	6381003	1
8	O-ring	8378175	1	29	Wire for Display Board	5512001	1
9	6300 Injector	5468005	1	30	Front Cover	8300008	1
	6800 Injector	Selection		31	Label	8865008	1
10	Screw, Cross	8902017	2	32	Weather Cover	8300015	1
11	O-ring	8378183	1	33	Dust Cover	8005013	1
12	O-ring	8378174	2	34	Wire for Power	5513001	1
13	Adjusting Screw	8906002	1	35	Probe Wire	6386001	1
14	Seal Ring	8370047	1	36	Screw, Cross	8909013	1
15	Fixed Disk	8469024	1	37	Screw, Cross	8909008	7
16	Moving Disk	8459026	1	38	Screw, Cross	8909044	4
17	Moving Seal Ring	8370137	1	39	Small Gear	8241015	1
18	Shaft	8258047	1	40	Pin	8993003	1
19	Anti-friction Washer	8216011	1	41	Motor	6158026	1
20	O-ring	8378111	2	42	Screw, Cross	8909016	4
21	O-ring	8378195	2				

F79B Valve Body Assembly

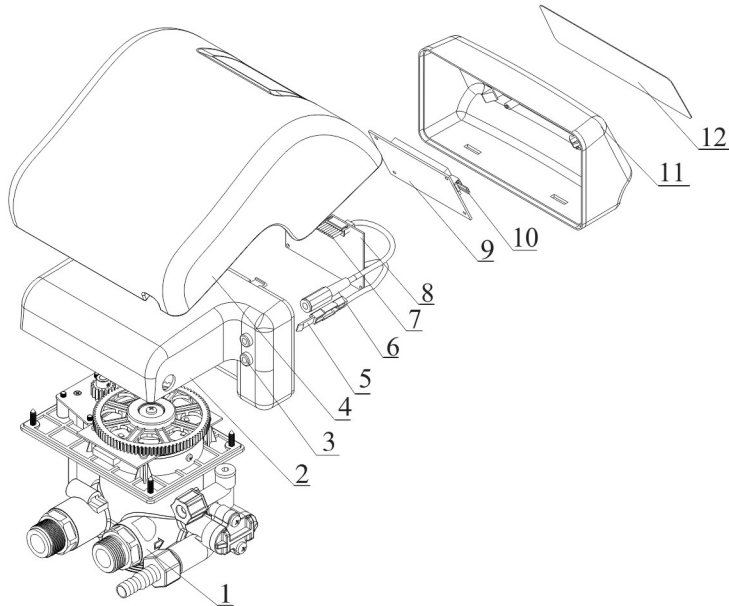

F79B Valve Body Components

Item No.	Description	Part No.	Quantity	Note
1	Valve Body Assembly	6794013	1	All the parts are the same as 83602 except the moving disk 8459027
2	Dust Cover	8005014	1	/
3	Cable Clip	8126004	2	/
4	Weather Cover	8300015	1	/
5	Probe Wire	6386001	1	/
6	Wire for Power	5513001	1	/
7	Wire for Locating Board	5511004	1	/
8	Control Board	6382021	1	/
9	Display Board	6381003	1	/
10	Wire for Display Board	5512001	1	/
11	Front Cover	8300004	1	/
12	Label	8865004	1	/

Flow Meter Connector & Animated Connector

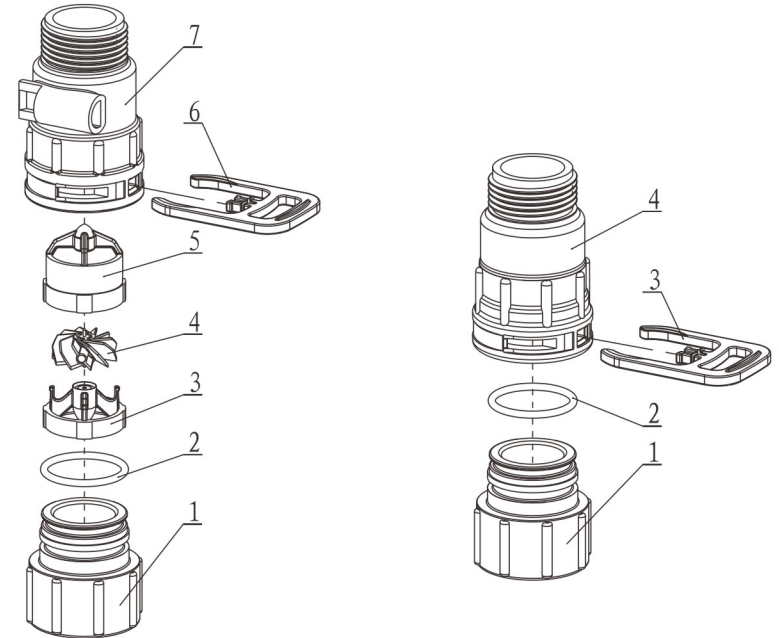

5447018 Flow Meter

5457002 Animated Connector

5447018 Flow Meter				5457002 Animated Connector			
Item No.	Description	Part No.	Quantity	Item No.	Description	Part No.	Quantity
1	Animated Nut	8945001	1	1	Animated Nut	8945001	1
2	O-ring	8378081	1	2	O-ring	8378081	1
3	Impeller Supporter	5115022	1	3	Clip	8270004	1
4	Impeller	5436010	1	4	Connector	8458038	1
5	Impeller Supporter	5115021	1				
6	Clip	8270004	1				
7	Shell	8002001	1				

F82A3, F82B3 Valve Body Assembly

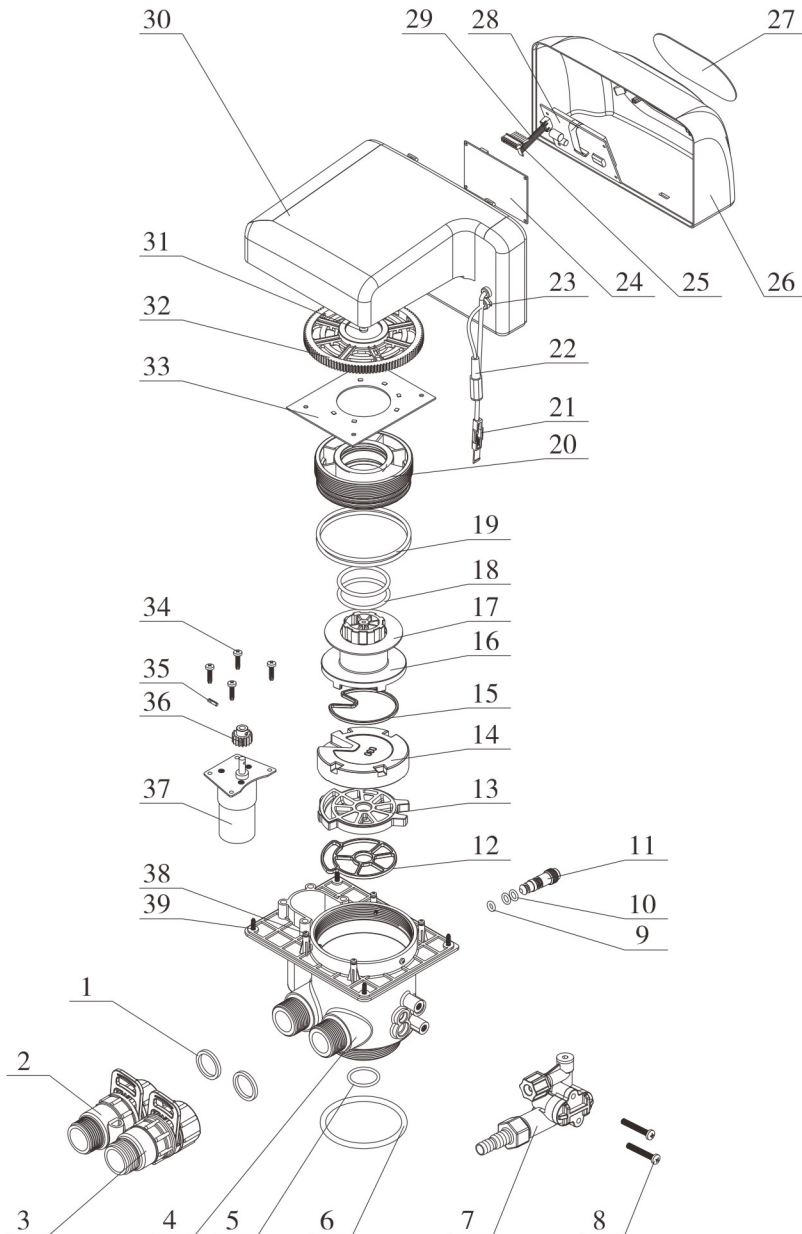

F82A3 /F82A1/F82B3/F82B1 Valve Body Components

Item No.	Description	Part No.				Quantity
		F82A1	F82A3	F82B1	F82B3	
1	Washer	/	8371001	/	8371001	2
2	Flow Meter	/	5447018	/	5447018	1
3	Animated Connector	/	5457002	/	5457002	1
4	Valve Body	5022030	5022030	5022030	5022030	1
5	O-ring	8378078	8378078	8378078	8378078	1
6	O-ring	8378143	8378143	8378143	8378143	1
7	6300 Injector	5468009	5468009	5468009	5468009	1
	6800 Injector	Selection				
8	Screw, Cross	8902017	8902017	8902017	8902017	2
9	O-ring	8378015	8378015	8378015	8378015	1
10	O-ring	8378004	8378004	8378004	8378004	2
11	Adjusting Screw	8906003	8906003	8906003	8906003	1
12	Seal Ring	8370049	8370049	8370049	8370049	1
13	Fixed Disk	8469026	8469026	8469026	8469026	1
14	Moving Disk	8459029	8459029	8459030	8459030	1
15	Moving Seal Ring	8370138	8370138	8370138	8370138	1
16	Shaft	8258048	8258048	8258048	8258048	1
17	Anti-friction Washer	8216012	8216012	8216012	8216012	1
18	O-ring	8378123	8378123	8378123	8378123	2
19	O-ring	8378102	8378102	8378102	8378102	2
20	Fitting Nut	8092012	8092012	8092012	8092012	1
21	Probe Wire	/	6386022	/	6386022	1
22	Wire for Power	5513001	5513001	5513001	5513001	1
23	Cable Clip	8126004	8126004	8126004	8126004	2
24	Control Board	6382021	6382021	6382021	6382021	1
25	Wire for Locating Board	5511004	5511004	5511004	5511004	1
26	Front Cover	8300017	8300017	8300007	8300007	1

MODEL: 83602-F79A3/83602B-F79B/83604-F82A3/83604B-F82B3

27	Label	8865016	8865016	8865007	8865007	1
28	Display Board	6381003	6381003	6381003	6381003	1
29	Wire for Display Board	5512001	5512001	5512001	5512001	1
30	Dust Cover	8005016	8005016	8005016	8005016	1
31	Screw, Cross	8909013	8909013	8909013	8909013	1
32	Gear	5241011	5241011	5241011	5241011	1
33	Locating Board	6380012	6380012	6380012	6380012	1
34	Screw, Cross	8909044	8909044	8909044	8909044	4
35	Pin	8993003	8993003	8993003	8993003	1
36	Small Gear	8241015	8241015	8241015	8241015	1
37	Motor	6158073	6158073	6158073	6158073	1
38	Screw, Cross	8909008	8909008	8909008	8909008	7
39	Screw, Cross	8909016	8909016	8909016	8909016	4

MODEL: 83602-F79A3/83602B-F79B/83604-F82A3/83604B-F82B3

F82AG3/F82BG3 Valve Body Assembly

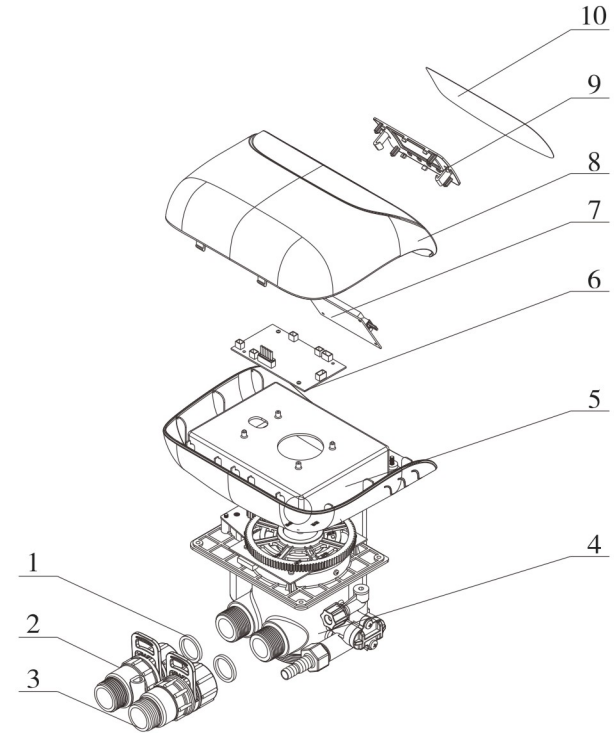

F82AG1/F82AG3/F82BG1/F82BG3 Valve Body Components:

Item	Description	Part No.				Quantity
		F82AG1	F82AG3	F82BG1	F82BG3	
1	Washer	/	8371001	/	8371001	2
2	Flow Meter	/	5447018	/	5447018	1
3	Animated Connector	/	5457002	/	5457002	1
4	Valve Body Assembly	Same as F82A1	Same as F82A3	Same as F82B1	Same as F82B3	1
5	Dust Cover	8005019	8005019	8005019	8005019	1
6	Control Board	6382021	6382021	6382021	6382021	1
7	Display Board	6381003	6381003	6381003	6381003	1
8	Front Cover	5300001	5300001	5300001	5300001	1
9	Toggle	8109027	8109027	8109027	8109027	1
10	Label	8865020	8865020	8865020	8865020	1

MODEL: 83602-F79A3/83602B-F79B/83604-F82A3/83604B-F82B3

Structure Chart of 6800 Injector:

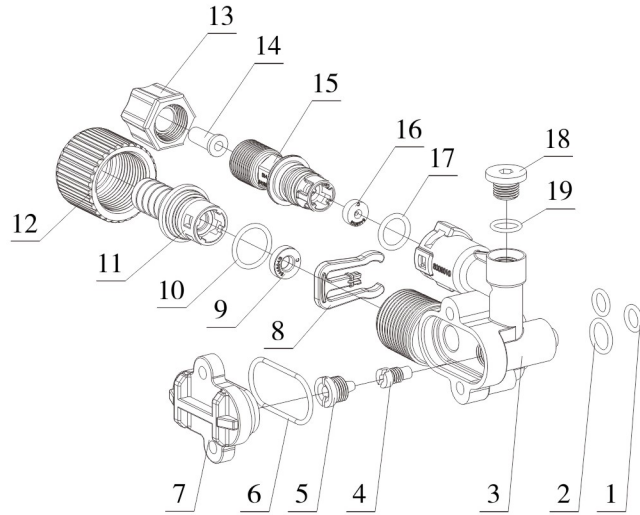

New Injector (6800 series) Components:

Item	Description	Part No.	Quantity	Item	Description	Part No.	Quantity
1	O-ring 7.5×1.8	8378016	2	11	Connector	8458064	1
2	O-ring 10.82×1.78	8378012	1	12	Animated Nut	8945025	1
3	Injector Body	8008010	1	13	Nut Nex. Hd	8940001	1
4	Throat	Optional	1	14	Tube	8457004	1
5	Nozzle	Optional	1	15	Connector	8458068	1
6	O-ring 30×1.8	8378025	1	16	BLFC	Optional	1
7	Injector Cover	8315001	1	17	O-ring 11×2	8378169	1
8	Clip	8270010	1	18	Plug	8323002	1
9	DLFC	Optional	1	19	Seal Ring	8370003	1
10	O-ring 15×1.8	8378179	1				

MODEL: 83602-F79A3/83602B-F79B/83604-F82A3/83604B-F82B3

Structure Chart of 6300 Injector:

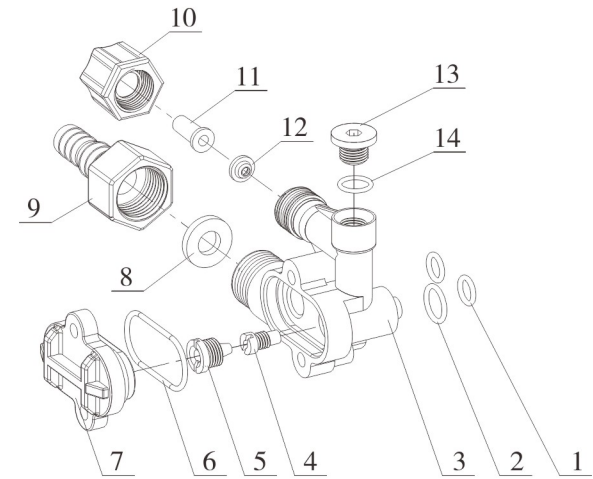

Old Injector (6300 series) Components:

Item	Description	Part No.	Quantity	Note	Item	Description	Part No.	Quantity	Note
1	O-ring 7.5×1.8	8378016	2		8	DLFC	8468005	1	F79
2	O-ring 10.82×1.78	8378012	1				8468007		F82
3	Injector Body	8008001	1		9	Connector	8458017	1	
4	Throat	8467005	1	F79	10	Nut Nex. Hd	8940001	1	
		8467009		F82	11	Tube	8457004	1	
5	Nozzle	8454005	1	F79	12	BLFC	8468002		
		8454009		F82	13	Plug	8323002	1	
6	O-ring 30×1.8	8378025	1		14	Seal Ring	8370003	1	
7	Injector Cover	8315001	1						

4. Warranty Card

Dear client:

This warranty card is the guarantee proof of Runxin brand multi-functional flow control valve. It is kept by client self. You could get the after-sales services from the supplier which is appointed by Runxin manufacturer. Please keep it properly. It couldn't be retrieved if lost. It couldn't be repaired free of charge under the below conditions:

1. Guarantee period expired. (One year)
2. Damage resulting from using, maintenance, and keeping that are not in accordance with the instruction.
3. Damage resulting from repairing not by the appointed maintenance personnel.
4. Content in guarantee proof is unconfirmed with the label on the real good or be altered.
5. Damage resulting from force majeure.

Product Name	 Multi-functional Flow Control Valve for Water Treatment Systems		
Model		Code of Valve Body	
Purchase Company Name		Tel/Cel.	
Problem			
Solution			
Date of Repairing		Date of Examination	Maintenance Man Signature

When product needs warranty service, please contact with your direct supplier firstly after got permission, then fill in the below content and send this card together with the product to the appointed suppliers or Runxin company.

End-user Company Name		Tel/Cel.	
Purchase Company Name		Tel/Cel.	
Model		Code of Valve Body	
Tank Size ϕ ×		Resin Volume L	Raw Water Hardness mmol/L
Water Source: Ground-water <input type="checkbox"/> Tap Water <input type="checkbox"/>		Water Treatment Capacity m ³	Backwash Time min
Brine & Slow Rinse Time min		Brine Refill Time min	Fast Rinse Time min
Problem Description			

●If there is no special requirement when product purchase, we will use following as the standard configuration.

F79 down-flow and up-flow match with 6305 old injector, with 8468005 (3#) DLFC;

F79 down-flow match with 6806 new injector (5468242), with 8468077 DLFC;

F79 up-flow match with 6803 new injector (5468252); with 8468077 DLFC;

F82 down-flow and up-flow match with 6309 old injector, with 8468007 (5#) DLFC;

F82 down-flow match with 6809 new injector (5468245), with 8468063 DLFC;

F82 up-flow match with 6806 new injector (5468255), with 8468063 DLFC.

Catalogue

Notice.....	3
1. Product Overview.....	4
1.1. Main Application & Applicability.....	4
1.2. Product Characteristics.....	4
1.3. Service Condition.....	6
1.4. Product Structure and Technical Parameters.....	8
1.5. Installation.....	10
2. Basic Setting & Usage.....	13
2.1. The Function of PC Board.....	13
2.2. Basic Setting & Usage.....	14
3. Applications.....	18
3.1. Softener Flow Chart.....	18
3.2. The Function and Connection of PC Board.....	20
A. Signal Output Connector.....	21
B. Interlock.....	24
C. Pressure Relief Output.....	24
D. Remote Handling Connector.....	25
E. Interlock System.....	25
F. Series System.....	25
3.3. System Configuration and Flow Rate Curve.....	26
3.4. Parameter Settlement.....	29
3.5. Parameter Enquiry and Setting.....	31
3.6. Trial Running.....	35
3.7. Trouble-Shooting.....	36
3.8. Assembly & Parts.....	40
4. Warranty Card.....	51

Notice

- To ensure normal operation of the valve, please consult with professional installation or repairing personnel before use it.
- If there are any of pipeline engineering and electric works, they must be finished by professional at the time of installation.
- Do not use the control valve with the water that is unsafe or unknown quality.
- Depending on the changing of working environment and water requirement, each parameter of softener should be adjusted accordingly.
- When the water treatment capacity is too low, please check the resin. If the reason is short of resin, please add; if the resin is turn to reddish brown or broken, please replace.
- Test water periodically to verify that system is performing satisfactorily.
- Ensure that there is solid salt all the time in the brine tank in the course of using, when this valve is used for softening. The brine tank should be added crystalline coarse salt only, at least 99.5% pure, forbidding use the small salt.
- Do not put the valve near the heat sources or surroundings with high humidity, corrosive, intense magnetic field or intense vibrations environment. And do not leave it outside.
- Forbidden to carry the injector body. Avoid to use injector body as support to carry the system.
- Forbidden to use the brine tube or other connectors as support to carry the system.
- Please use this product under the water temperature between 5 ~ 50℃, water pressure 0.15 ~ 0.6MPa. Failure to use this product under such conditions voids the warranty.
- If the water pressure exceeds 0.6MPa, a pressure reducing valve must be installed before the water inlet. While, if the water pressure is under 0.15MPa, a booster pump must be installed before the water inlet.
- PPR pipes, corrugated pipes, or UPVC pipes are recommended for pipe installation and aluminum-plastic pipes should be avoided.
- Do not let children touch or play, because careless operations may cause the procedure changed.
- When the attached cables of this product and transformer are damaged, they must be changed to the one that is from our factory.

1. Product Overview

1.1. Main Application & Applicability

Used for intelligent softening or demineralization water treatment systems

Be suitable for

- Residential softening or filtration system
- Ion exchange equipment
- Boiler softening water system
- RO pre-treatment softening system, etc.

1.2 Product Characteristics

● Simple structure and reliable sealing

It adopts hermetic head faces with high degree pottery and corrosion resistance for opening and closing. It combines with Service, Backwash, Brine & Slow Rinse, Brine Refill and Fast Rinse.

● Manual function

Realize regeneration immediately by pressing  at any time.



● Long outage indicator

If outage overrides 3 days, the time of day indicator "12:12" will flash to remind the people to reset new time of day. The other set parameters do not need to reset. The process will continue to work after power on.

● LED dynamic screen display

The stripe on dynamic screen flash, it indicates the control valve is in service, otherwise, it is in regeneration cycle.

● Buttons lock

No operations to buttons on the controller within 1 minute, button lock indicator lights on which represent buttons are locked. Before operation, press and hold the  and  buttons for 5 seconds to unlock. This function can avoid incorrect operation.

● The F79 with weather cover can be installed outside.

● Has hard water bypass and no hard water bypass two choices.

No hard water bypass refers to the control valve no water pass when valve in regeneration. Model: A for no hard water bypass (No raw water flows out from outlet when in regeneration process); B for with hard water bypass. (With raw water flows out from outlet when in regeneration process)

● With partial bypass function

In service, by adjusting bypass screw can let part of raw water flows into the outlet without being softened.

● Down-flow regeneration, up-flow regeneration and filter can be implemented with one valve.

By program selection to choose following modes

Mode	Name	Instruction
A-01	Down-flow Regeneration, Meter Delayed	Down-flow regeneration, will not regenerate although the available volume of treated water drops to zero (0). Regeneration will start until at the regeneration time.
A-02	Down-flow Regeneration, Meter Immediate	Down-flow regeneration, regenerate immediately when the available volume of treated water drops to zero (0).
A-03	Down-flow Regeneration, Intelligent Meter Delayed	Down-flow regeneration, will not regenerate although the available volume of treated water drops to zero (0). Regeneration will start until at the regeneration time. (By setting resin volume, raw water hardness, regeneration factor, the controller will calculate the system capacity.)
A-04	Down-flow Regeneration By Day	Down-flow regeneration, regenerate when the service days reach to zero (0) and at the regeneration time.
A-05	Down-flow Regeneration By Hour	Down-flow regeneration, regenerate when time drops to zero (0).
A-11	Up-flow Regeneration, Meter Delayed	Up-flow regeneration, will not regenerate although the available volume water of treated water drops to zero (0). Regeneration will start until at the regeneration time.
A-12	Up-flow Regeneration, Meter Immediate	Up-flow regeneration, regenerate when the available volume of treated water drops to zero (0).
A-13	Up-flow Regeneration, Intelligent Meter Delayed	Up flow regeneration, will not regenerate although the available volume water of treated water drops to zero (0). Regeneration will start until at the regeneration time. (By setting resin volume, feed water hardness, regeneration factor, the controller will calculate the system capacity.)
A-14	Up-flow Regeneration By Day	Up-flow regeneration, regenerate when the service days reach to zero (0). Regeneration will start until at the regeneration time.
A-15	Up-flow Regeneration By Hour	Up-flow regeneration, regenerate when time drops to zero (0).
A-21	Filter Type	Filter type, rinsing when the service days reach to zero (0) and the current time is matched with rinsing time.

● Interval backwash times (Only suitable for up-flow regeneration type)

It could set up interval backwash times for up-flow type A-11, 12, 13, 14, 15, which means several times of services but one time of backwash. The setting of interval backwash time depends on the local water turbidity. (The lower the turbidity is, the longer the interval backwash time can be set)

● **Rinsing frequency**

It could set up rinsing frequency when selection of filter mode A-21, which means several times of backwash and fast rinse but one time of service (Can be set). In this working mode, the brine line connector needs be sucked and DLFC needs to be taken off.

● **Signal output**

There is a signal output connector on main control board. It is for controlling external wiring (Refers to Figure 3-1 to Figure 3-8).

There are two kinds of output modes.

b-01 Mode: Turn on start of regeneration and shut off at the end of regeneration; b-02 Mode: Signal available only in intervals of regeneration cycles and in service.

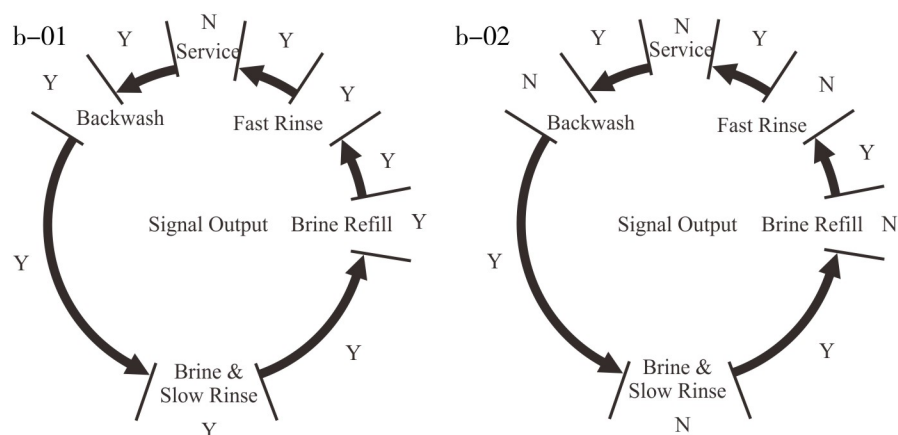

● **Remote handling input**

This connector can receive external signal, used together with PLC, and computer etc. to control the valve. (Application refers to Figure 3-11)

● **Disinfection connector (It is necessary to separately match with a disinfection device that is additional device.)**

The valve has the disinfection connector, which can supply DC5V, 200mA power output in the brine status. It can make a part of brine water electrolyzed, and produce hypochlorous acid to sterilize and disinfect the resin.

● **Connector of salt shortage alarm (It is necessary to separately match with a gravity meter.)**

The connector is jointed with gravity meter. When the brine tank is short of salt, the system will give the alarm and remind user to add the salt in time. (Wiring refers to P20)

● **Maximum interval regeneration days**

In mode A-01/02/03 or A-11/12/13, under the situation of service reaching the setting days but the volume not yet, it could enter into regeneration process forcibly when current time is the same as regeneration time.

● **All parameters can be modified**

According to the water quality and usage, the parameters in the process can be adjusted.

1.3 Service Condition

Runxin valve should be used under the below conditions:

Items		Requirement
Working Conditions	Working Pressure	0.15MPa ~ 0.6MPa
	Water Temperature	5°C ~ 50°C
Working Environment	Environment Temperature	5°C ~ 50°C
	Relative Humidity	≤95% (25°C)
	Electrical Facility	AC100 ~ 240V/50 ~ 60Hz
Inlet Water Quality	Water Turbidity	Down-flow Regeneration <5FTU; Up-flow Regeneration <2FTU
	Water Hardness	First Grade Na ⁺ <6.5mmol/L; Second Grade Na ⁺ <10mmol/L
	Free Chlorine	< 0.1 mg/L
	Iron ²⁺	< 0.3 mg/L
	CODMn	< 2mg/L(O ₂)

In the above table, First Grade Na⁺ represents First Grade Na⁺ Exchanger. Second Grade Na⁺ represents Second Grade Na⁺ Exchanger.

● When the water turbidity exceeds the conditions, a filter should be installed on the inlet of control valve.

● When the water hardness exceeds the conditions, the outlet water hardness will hardly reach the requirement of boiler feed water (≤0.03 mmol/L). It is suggested to adopt second grade softener.

1.4 Product Structure and Technical Parameters

A. Product Dimension (The appearance is just for reference. It is subjected to the real product.)

F79A/F79B (83602/83602B)

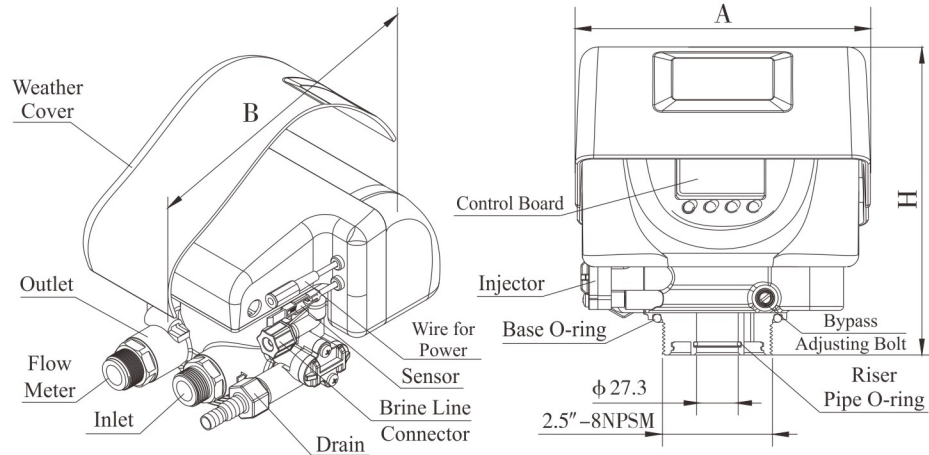

F82A (83604) /F82B (83604B)

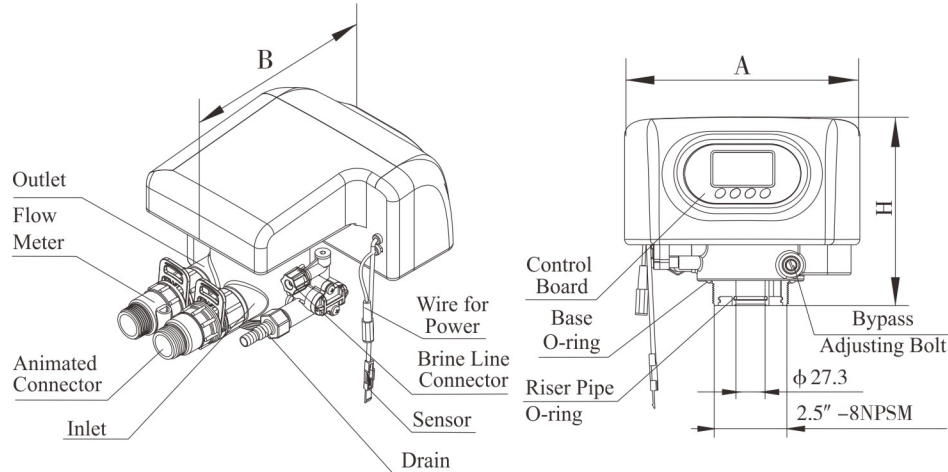

F82AG (83604AB)/F82BG (83604BB)

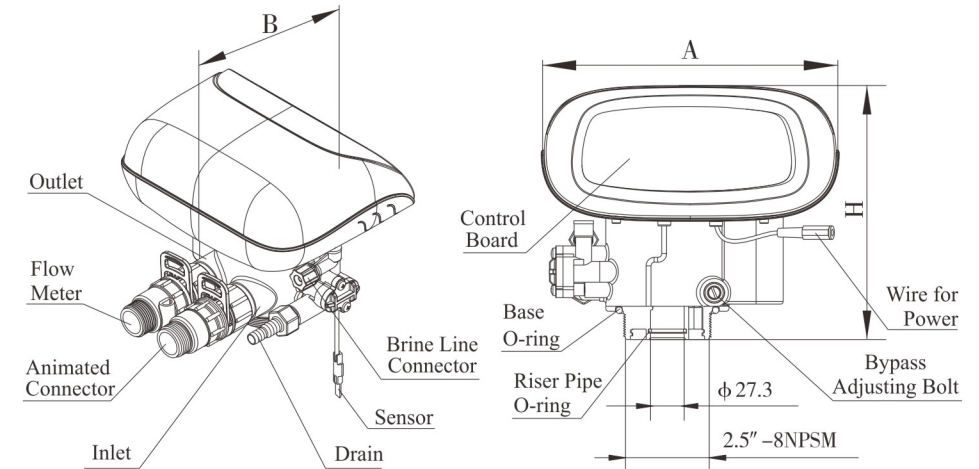

Model	A(mm)max	B(mm)max	H(mm)max
F79A/F79B	186	230	200
F82A/F82B	220	260	180
F82AG/F82BG	240	200	205

B. Technical Parameter

Control valve are suitable for the power adapter output: DC12V、1.5A

Model	Connector Size					Water Capacity m ³ /h @0.3MPa	Remark
	Inlet/ Outlet	Drain	Brine Line Connector	Base	Riser Pipe		
F79A	3/4" M	1/2" M	3/8" M	2-1/2" -8NPSM	1.05" OD (26.7mm)	2	No raw water pass valve when regeneration
F79B							With raw water pass valve when regeneration
F82A	1" M	1/2" M	3/8" M	2-1/2" -8NPSM	1.05" OD (26.7mm)	3.5	No raw water pass valve when regeneration
F82B							With raw water pass valve when regeneration
F82AG	1" M	1/2" M	3/8" M	2-1/2" -8NPSM	1.05" OD (26.7mm)	3.5	No raw water pass valve when regeneration
F82BG							With raw water pass valve when regeneration

Note: M-Male thread F-Female thread OD-Outer diameter

1.5 Installation

A. Installation Notice

Before installation, read all those instructions completely. Then obtain all materials and tools needed for installation.

The installation of product, pipes and circuits should be accomplished by professional to ensure that the product can operate normally.

Perform installation according to the relevant pipeline regulations and the specifications of Water Inlet, Water Outlet, Drain Outlet, and Brine Line Connector.

B. Device Location

- ①The filter or softener should be located close to the drain.
- ②Ensure the unit is installed in enough space for operating and maintenance.
- ③Brine tank needs to be close to softener.
- ④The unit should be kept away from the heater, and not be exposed outdoor. Sunshine or rain will cause the system damage.
- ⑤Avoid installing the system in circumstance of acid/alkaline, magnetic or strong vibration, because above factors will cause the system disorder.
- ⑥Do not install the filter or softener, drain pipeline or overflow pipe in circumstance where temperature may drop below 5°C, or above 50°C.
- ⑦Install the system in the place where with the minimum loss in case of water leakage.

C. Pipeline Installation (Exemplated as F82)

①Install control valve

a. As the Figure 1-1 shows, select the riser pipe with 26.7mm OD, glue the riser pipe to the bottom strainer and put it into the resin tank, cut off the exceeding pipe out of tank top opening and make external rounding.

b. Fill the resin to the tank, and the height is in accordance with the design code.

c. Install the top strainer to the valve.

d. Through the top strainer, insert the riser pipe into control valve and screw tight control valve.

Note:

- The length of riser pipe should be neither 2mm higher nor 5mm lower than tank top opening, and its top end should be rounded to avoid damaging of O-ring inside the valve.
- Avoid filling floccules substance together with resin to the resin tank.
- Avoid O-ring inside control valve falling out while rotating it on the tank.

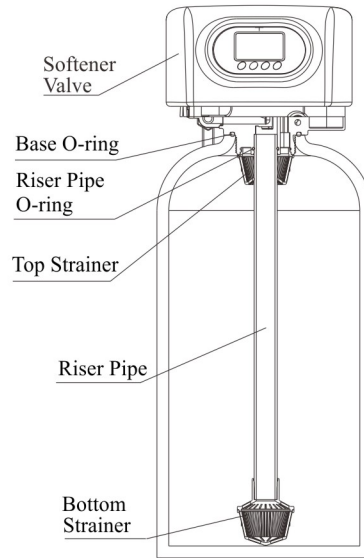

Figure1-1

②Install animated connector

As Figure1-2 shows, put the sealing ring into nut of animated connector, and screw in water inlet.

③Install flow meter

As Figure1-2 shows, put the sealing ring into nut of flow meter, screw in water outlet; insert the sensor into flow meter.

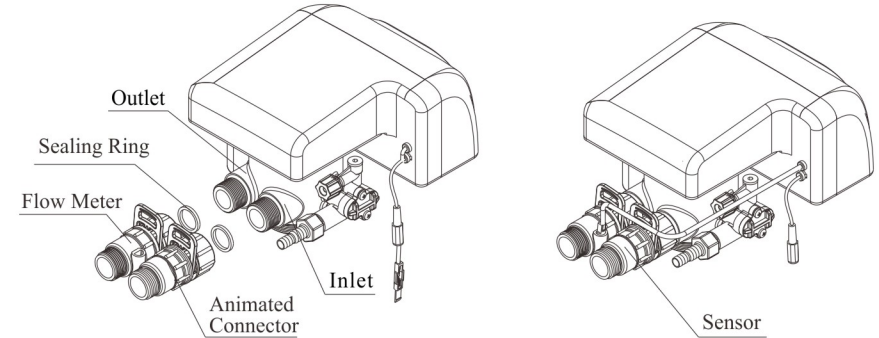

Figure1-2

④Pipeline Connection

a. As Figure1-3 shows, install a pressure gauge in water inlet.

b. Install valve A, valve B, valve C and valve D in the inlet, outlet and middle of the pipeline. The valve D is sampling valve. (Or adopt F70C/F70D bypass valve).

c. Inlet pipeline should be in parallel with outlet pipeline. Support inlet and outlet pipeline with fixed holder.

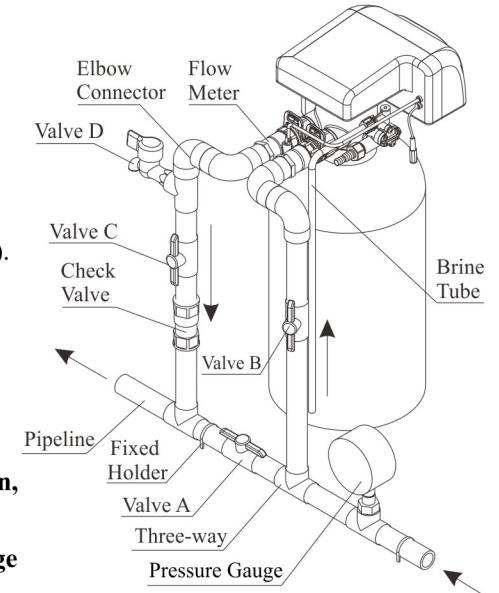

Figure1-3

Note:

- If making a soldered copper installation, do all sweat soldering before connecting pipes to the valve. Torch heat will damage plastic parts.
- When turning threaded pipe fitting onto plastic fitting, do not use excessive force to make threads misaligned or broken valve.
- If the valve belongs to time clock type or F79, there are no step ② and ③.

⑤ Install drain pipeline

- As the Figure 1-4 shows, slide the drain hose connector into drain outlet.
- Insert drain line flow control into drain outlet.
- Screw drain hose connector into drain outlet, and lock it.
- Locate the drain hose well as the Figure 1-4 shows.

Note:

- Control valve should be higher than drain outlet, and be better not far from the drain hose.
- Be sure not connect drain with sewer directly, and leave a certain space between them, avoid wastewater being absorbing to the water treatment equipment, such as showed in the Figure1-4. If want to use the wastewater for other using, it can be filled with a corresponding container. Similarly, the drain pipe should be kept a certain space with the container.

⑥ Connect brine tube

- As Figure1-5 shows, slide 3/8" brine tube hose connector over end of brine tube.
- Insert tube bushing into the end of brine tube.
- Insert the red brine line flow control into valve brine line connector (Note: cone side of control should face into valve).
- Tighten nut onto brine line connector.
- Connect the other end of brine tube with the brine tank. (The liquid level controller and air-blocker should be installed in the brine tank.)

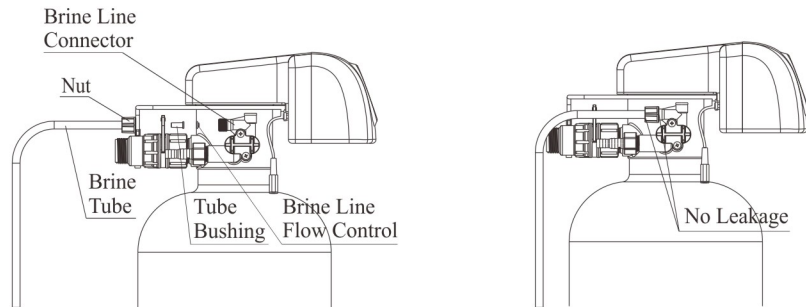
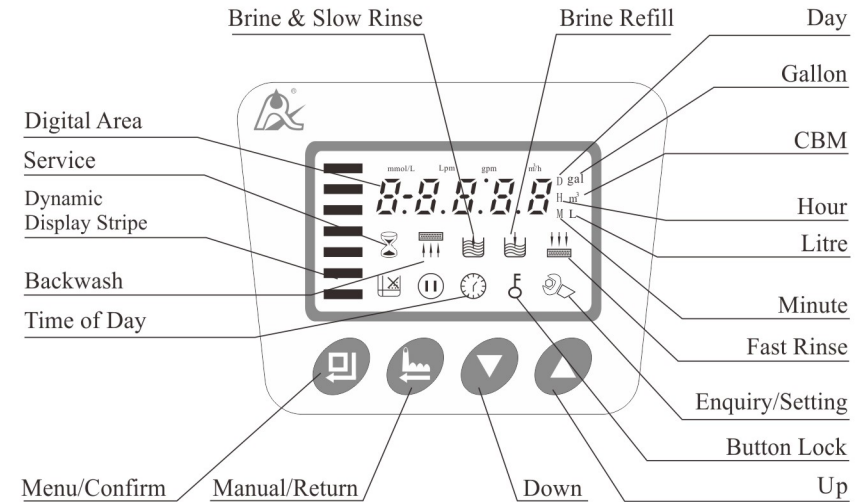

Figure 1-5

Note: The brine tube and drain pipeline should not be bended or plugged.

2. Basic Setting & Usage

2.1 The Function of PC Board



A. ⌚ Time of Day Indicator

- ⌚ Lights on, display the time of day.
- “12:12” flashes, remind user to reset the time of day if the electric service interrupted 3 days more (If the electric service interrupted within 3 days, it doesn't need to reset the time.)

B. 🔒 Button Lock Indicator

- 🔒 Lights on, indicate the buttons are locked. At this moment, pressing any single button will not work (No operation in one minute, 🔒 will light on and lock the buttons.)
- Solution: Press and hold both ▲ and ▼ for 5 seconds until the 🔒 lights off.







C. 🔄 Program Mode Indicator



- 🔄 Lights on, enter program display mode. Use ▲ or ▼ to view all values.
- 🔄 Flashes and enter program set mode. Press ▲ or ▼ to adjust values.







D. 🗑️ Menu/Confirm Button

- In menu mode, press 🗑️ and 🔄 lights on, then enter program display mode to view all values.
- In program display mode, press 🗑️, 🔄 flashes, enter program set mode, press ▲ or ▼ to adjust values.
- Press 🗑️ after all program are set, and then the voice “Di” means all setting are successful and return program display mode.

E.  Manual/Return Button

- Press  in any status, it can proceed to next step. (Example: After unlock the buttons, press  in service status, it will start regeneration cycles instantly if the outlet water is unqualified; Press  while it is in backwash status, it will end backwash and go to brine & slow rinse at once.)
- Press  in program display mode, and it will return in service; Press  in program set mode, and it will return program display mode.
- Press  while adjusting the values, then it will return to program display mode directly without saving value.







F. Up  and Down 

- In program display mode, press  or  to view all values.
- In program set mode, press  or  to adjust values.
- Press and hold both  and  for 5 seconds to unlock the buttons.

2.2. Basic Setting & Usage

A. Parameter Specification

Function	Indicator	Factory Default	Parameter Set Range	Instruction
Time of Day		Random	00:00~23:59	Set the time of day when use; “:” flashes.
Control Model	A-01	A-01	A-01	Down-flow, Meter Delayed: Regenerate will not start although the available volume of treated water drops to zero (0). Regeneration will start until at the regeneration time.
			A-02	Down-flow, Meter Immediate: Regenerate immediately when the available volume of treated water drops to zero (0).
			A-03	Down-flow, Intelligent Meter Delayed: By setting resin volume, raw water hardness, regeneration factor, the controller will calculate the system capacity. Regeneration mode same as A-01.
			A-04	Down-flow Regeneration, by day type, regenerate when the service days reach to zero (0) and at the regeneration time.
			A-05	Down-flow Regeneration, by hour type, regenerate immediately when time drops to zero (0).
			A-11	Up-flow Regeneration, Meter Delayed, regeneration mode is the same with A-01.

Control Model	A-01	A-01	A-12	Up-flow Regeneration, Meter Immediately, regeneration mode is same as A-02.
			A-13	Up-flow, Intelligent Meter Delayed: Regeneration mode is same as A-03.
			A-14	Up-flow Regeneration, by day, regeneration mode is same as A-04.
			A-15	Up-flow Regeneration, by hour, regeneration mode is same as A-05.
			A-21	Filter type, rinsing when the service days or available capacity reach to zero (0) and the current time is matched with rinsing time.
Unit Mode	HU-01	HU-01	01, 02, 03	01-m ³ ; 02-gal; 03-L
Service Days		1-03D	0~99 Days	Only for Time Clock Type, regeneration by days.
Service Hours		1-20H	0~99 Hours	Only for Time Clock Type, regeneration by hours.
Regeneration Time	02:00	02:00	00:00~23:59	Regeneration time; “:” lights on.
Interval Backwash Times	F-00	00	0~20	Interval backwash times. For example, F-01: indicates service 2 times, backwash 1 time (only for A-11/12/13/14/15).
Rinsing Frequency	F-00	00	0~20	Rinsing added times. For example, F-01: indicates rinse 2 times, service 1 time (Only for A-21)
Resin Volume	50L	50L	5~500L	Resin volume in brine tank (L), for A-03/13
Raw Water Hardness	Yd1.2	1.2	0.1~9.9	Raw water hardness (mmol/L), for A-03/13
Exchange Factor	AL.65	0.65	0.30~0.99	Relate to the raw water hardness. When hardness is higher, the factor is smaller. For A-03/13
Water Treatment Capacity		10m ³	0~99.99m ³	Water treatment capacity in one circle (m ³), for A-01/02/11/12
Backwash Time		10min.	0~99:59	Backwash time (minute)
Brine & Slow Rinse Time		60min.	0~99:59	Brine & slow rinse time (minute)
Brine Refill Time		5min.	0~99:59	Brine refill time (minute)