



WENZHOU RUNXIN MANUFACTURING MACHINE CO.,LTD

ADD: Jinger Road, Shatou Group, Linjiang, Lucheng District, Wenzhou, Zhejiang, China
Tel: +86-577-88635628 88630038 Fax: +86-0577-88633258
Http://www.run-xin.com Email:sales@run-xin.com



International Patent Public No.:
WO 2006/007772
China Patent No.: ZL02220153.X,
ZL200420062895.3
US Patent No.: 7549446
India Patent No.: 232582
Russia Patent No.:2349819
South Korea Patent No.:10-0914137
Mexico Patent No.: 268581
Australia Patent No.: 2005263257
Philippine Patent No.: 1-2006-502553
Taiwan Patent No.:M287896

Multi-functional Flow Control Valve for Water Treatment Systems

53520 (F95B1)
53620 (F95B3)
63520 (F95A1)
63620 (F95A3)
73520 (F95D1)
73620 (F95D3)
93520 (F95C1)
93620 (F95C3)

Instruction Manual



Please read this manual in details
before using this valve and keep it properly
in order to consult in the future

0WRX.466.553

Before the valve put into use, please fill in the below content so as to help us to refer in the future.

Softener System Configuration

Tank Size: Dia. _____mm, Height _____mm;
 Resin Volume _____L; Brine Tank Capacity _____L;
 Hardness of Raw Water _____mmol/L;
 Pressure of Inlet Water _____MPa;
 Control Valve Model _____; Number _____;
 The Specification of Drain Line Flow Control _____;
 Injector No. _____.
 Water Source: Ground-water Filtered Ground-water Tap Water Other

Parameter Set

Parameter	Unit	Factory Default	Actual Value
Control Mode A-01/02/03/04 (Meter type)F95B only has A-01/02	/	A-01	
Water Treatment Capacity (Meter type)	m ³	200	
Service Days (Time clock type, by days)	D	03	
Regeneration Time	/	02:00	
Settling Bed Time (Only for F95C1/3)	min:sec	10:00	
Backwash Time (Only for F95A/B/D)	min:sec	10:00	
Brine & Slow Rinse Time (Only for F95A/C/D)	min:sec	60:00	
Brine Refill Time (Only for F95A/C/D)	min:sec	05:00	
Fast Rinse Time	min:sec	10:00	
Interval Regeneration Days (Not for Time clock type)	D	30	
Output Mode b-01(02) (Not for F95C)	/	b-01	

● If there is no special requirement when product purchase, we choose 4# drain line flow control of 63620/63520/73620/73520 (Drill three $\phi 6$ holes) and 4# injector for the standard configuration(7704). We choose 1# drain line flow control of 93620/93520(No drill $\phi 6$ hole) and 1# injector for the standard configuration(7701).

Catalogue

Notice

1. Product Overview.....	2
1.1. Main Application & Applicability.....	2
1.2. Product Characteristics.....	2
1.3. Service Condition.....	5
1.4. Product Structure and Technical Parameters.....	6
1.5. Installation.....	8
2. Basic Setting & Usage.....	14
2.1. The Function of PC Board.....	14
2.2. Basic Setting & Usage.....	15
3. Applications.....	18
3.1. Flow Chart.....	18
3.2. The Function and Connection of PC Board.....	20
A. Signal Output Connector.....	21
B. Interlock.....	23
C. Pressure Relief Output.....	24
D. Remote Handling Connector.....	24
E. Interlock System.....	25
F. Series System.....	25
G. Inlet Pump and Soft Water Pump for Floating Bed.....	25
3.3. System Configuration and Flow Rate Curve.....	28
3.4. Parameter Settlement.....	31
3.5. Parameter Enquiry and Setting.....	33
3.6. Trial Running.....	37
3.7. Trouble-shooting.....	38
3.8. Assembly & Parts.....	42
4. Warranty Card.....	50

Notice

- To ensure normal operation of the valve, please consult with professional installation or repairing personnel before use it.
- If there are any of pipeline engineering and electric works, there must be finished by professional at the time of installation.
- Do not use the control valve with the water that is unsafe or unknown quality.
- Depending on the changing of working environment and water requirement, each parameter of softener should be adjusted accordingly.
- When the water treatment capacity is too low, please check the resin. If the reason is shortage of resin, please add; if the resin is turn to reddish brown or broken, please replace.
- Test water periodically to verify that system is performing satisfactorily.
- Ensure that there is solid salt all the time in the brine tank in the course of using, when this valve is used for softening. The brine tank should be added the clean water softening salts only, at least 99.5% pure, forbidding use the small salt.
- Do not put the valve near the hot resource, high humidity, corrosive, intense magnetic field or intense vibrations environment. And do not leave it outside.
- Forbidden to carry the injector body. Avoid to use injector body as support to carry the system.
- Forbidden to use the brine tube or other connectors as support to carry the system.
- Please use this product under the water temperature between 5~50 ℃, water pressure 0.2~0.6 MPa. Failure to use this product under such conditions voids the warranty.
- If the water pressure exceeds 0.6 Mpa, a pressure reducing valve must be installed before the water inlet. While, if the water pressure under 0.2MPa, a booster pump must be installed before the water inlet.
- It is suggested to install PPR pipe, corrugated pipe or UPVC pipe, instead of TTLSG pipe. Keep the pipeline straight.
- Do not let children touch or play, because carelessness operating may cause the procedure changed.
- When the attached cables of this product and transformer are changed, they must be changed to the one that is from our factory.

1. Product Overview

1.1. Main Application & Applicability

Used for softening, demineralization or filtration water treatment systems 53520/53620 (Filtration), suitable for swimming pool filter system.

Filtration system

Activated carbon filter or sand filter of RO pretreatment system.

63520/63620(Down-flow regeneration softener)

73520/73620 (Up-flow regeneration softener), suitable for

Ion exchange equipment, the raw water hardness $\leq 6.5\text{mmol/L}$.

Boiler softening water system

RO pretreatment softening system, etc.

93520/93620(Floating bed softener) , suitable for

Ion exchange equipment, the raw water hardness $<15\text{mmol/L}$.

Boiler softening water system

RO pretreatment softening system, etc.

1.2. Product Characteristics

- Simple structure and reliable sealing

It adopts hermetic head faces with high degree pottery and corrosion resistance for opening and closing. It combines with Service, Backwash, Brine & Slow Rinse, Brine Refill and Fast Rinse.

- No water pass the valve in regeneration in single tank type.

- Brine refill controlled by electronic ball valve.

During service, electronic ball valve will control to start the brine refill. In order to short the regeneration cycle time.

During service, floating bed control valve refill softened water, fixed bed control valve refill hard water.

- Down/Up flow softener valve can change to filter valve

Block the brine line connector and remove the drain connector of 63520/73520 , it will be 53520.

Block the brine line connector and remove the drain connector of 63620/73620 , it will be 53620.

- Manual function

Realize regeneration immediately by pushing “” at any time.



- Long outage indicator

If outage overrides 3 days, the time of day indicator “” will flash to remind people to reset new time of day. The other set parameters do not need to reset. The process will continue to work after power on.





- LED dynamic screen display

The stripe on dynamic screen flash, it indicates the control valve is in service, otherwise, it is in regeneration cycle.

- Buttons lock

No operations to buttons on the controller within 1 minute, button lock indicator light on which represent buttons are locked. Before operation press and hold the “”and“” buttons for 5 seconds to unlock. This function can avoid incorrect operation.

- It can choose all models by program selection

Press and hold “” and“” buttons more than 2 seconds when all icons light on, can be enter into the model setting interface. Press“”or“” can choose the model you need, and press  save to the setting , after reconnect the power, the model will be showed on display board.

- Interlock function

It has a function of interlock to realize only one valve in regeneration but the other valves are in service while several valves parallel in system. In multi-steps treatment systems such as RO pre-treatment, when several valves are in series, there is only one valve in regeneration or washing to ensure pass water all the times.(Application refer to Figure 3-9)

- Signal output (Only for 63620/63520/73620/73520)

There is a signal output connector on main control board. It is for controlling external wiring (Refer to Figure from Figure3-1 to Figure 3-8).

There are two kinds of output modes: b-01 Mode: Turn on start of regeneration and shut off end of regeneration; b-02 Mode: Signal available only intervals of each status.

b-01

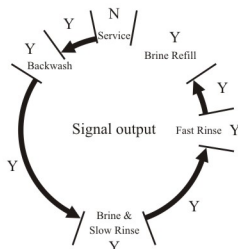

b-02

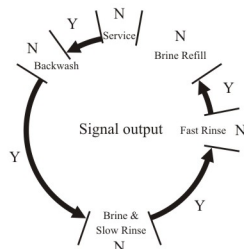

- Remote handling input

This connector can receive external signal, used together with PLC, and computer etc. to control the valve. (Application refer to Figure3-11)

- Pressure relief output

The valve will cut off feeding water to drain line when it switches in regeneration cycles (Same as signal output b-02). Thus in some water treatment system, e.g. Deep Well, one booster pump was installed on the inlet to increase the system water feeding pressure, this cut-off will cause pressure on inlet rising too fast to damage the valve. Pressure Relief Output can be used to avoid this problem. (Application refer to Figure3-10)

- All parameters can be modified

According to the water quality and usage, the parameters in the process can be adjusted.

Four kinds of meter type can be selected (Suit for 63620/73620/93620)

Model	Name	Instruction
A-01	Meter Delayed	Regenerate on the day although the available volume of treated water drops to zero (0). Regeneration starts at the regeneration time or swash.
A-02	Meter Immediate	Regenerate immediately or swash when the available volume of treated water drops to zero(0).
A-03	Intelligent Meter Delayed	Meter Delayed Regeneration type, but by setting Resin Volume, Feed Water Hardness, Regeneration Factor, the controller will calculate the System Capacity. Regeneration mode is the same as A-01.
A-04	Intelligent Meter Immediate	Meter Immediately Regeneration Type, but by setting Resin Volume, Feed Water Hardness, Regeneration Factor, the controller will calculate the System Capacity.

A-01, A-02 only suit for 53620.

- Maximum interval regeneration days (Suit for 53620/63620/73620/93620)

Under the situation of service reaching the setting days and the volume not yet, it could enter into regeneration process forcibly when current time is the same as regeneration time.

1.3. Service Condition

Runxin Valve should be used under the below conditions:

Items		Requirement
Working conditions	Water pressure	0.2MPa ~ 0.6MPa
	Water temperature	5℃ ~ 50℃
Working environment	Environment temperature	5℃ ~ 50℃
	Relative humidity	≤95% (25℃)
	Electrical facility	AC100 ~ 240V/50 ~ 60Hz
Inlet water quality	Water turbidity	Down Flow Softener (63520/63620) <5FTU ; Up Flow Softener (73520/73620) < 2FTU; Floating Bed (93520/93620) 2FTU Filter (53520/53620) < 20FTU
	Water hardness	First Grade Na+ < 6.5mmol/L ; Second Grade Na+ < 10mmol/L
	Free chlorine	< 0.1mg/L
	Iron ²⁺	< 0.3mg/L
	CODMn	< 2mg/L (O ₂)

In the above table, First Grade Na+ represents First Grade Na+ Exchanger. Second Grade Na+ represents Second Grade Na+ Exchanger.

When the water turbidity exceeds the conditions, a filter should be installed on the inlet of control valve.

When the water hardness exceeds the conditions, the outlet water hardness will hardly reach the requirement of boiler feed water (0.03 mmol/L) . It is suggested to adopt second grade softener.

1.4. Product Structure and Technical Parameters

A. Product dimension (The appearance is just for reference. It is subjected to the real product.)

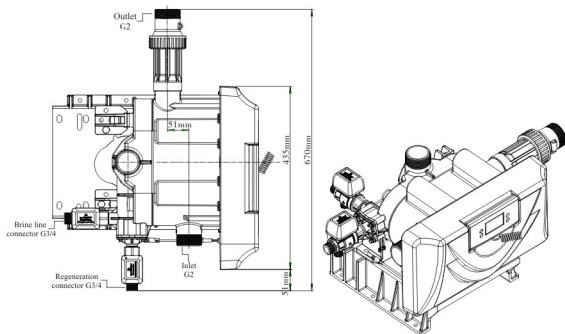
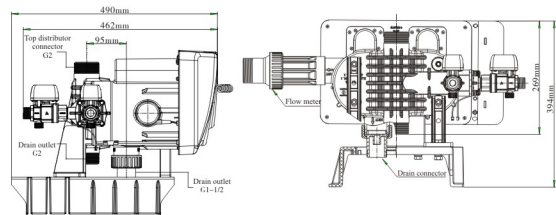

93620 Structural drawing

Note:

Remove the flow meter from 93620, it will be 93520;

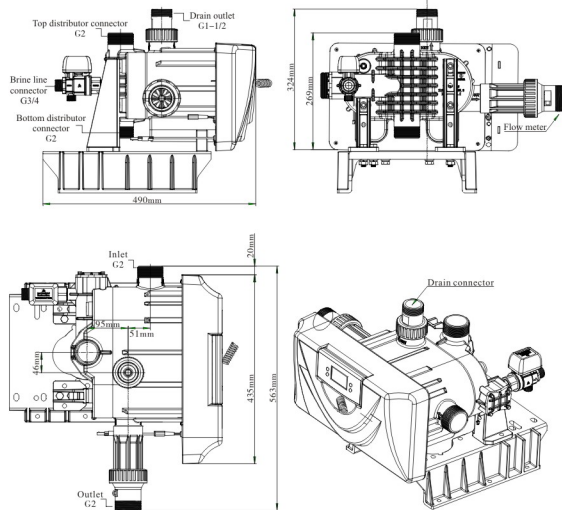

63620 Structural drawing

Note:

63620 not install the flow meter, it will be 63520.

Remove the brine line connector electronic ball valve, use blind hole nut to block and remove the drain line connector of 63620, it will be 53620.

Remove the brine line connector electronic ball valve, use blind hole nut to block and remove the drain line connector of 63520, it will be 53520.

Both 73620 and 63620 are same structural drawing.

Both 73520 and 63520 are same structural drawing.

B. Technical parameter**Transformer Output: DC24V/1.5A**

Model	Connector Size					Flow Rate m ³ /h @0.2MPa	Remark
	Inlet/Outlet	Drain Outlet	Brine Line Connector	Base	Riser Pipea		
53620	2" M	2" M	/	/	2" M	21.6	Filter, meter type
53520							Filter, time clock type
63620	2" M	1.5" M	3/4" M	/	2" M	21.6	DF softener, meter type
63520							DF softener, time clock type
73620	2" M	1.5" M	3/4" M	/	2" M	21.6	UF softener, meter type
73520							UF softener, time clock type
93620	2" M	1.5" M	3/4" M	3/4" M	2" M	20.5	Floating bed, meter type
93520							Floating bed, time clock type

Remark: M—Male F—Female

1.5. Installation**A. Installation notice**

Before installation, read all those instructions completely. Then obtain all materials and tools needed for installation.

The installation of product, pipes and circuits, should be accomplished by professional to ensure the product can operate normally.

Perform installation according to the relative pipeline regulations and the specification of Water Inlet, Water Outlet, Drain Outlet, and Brine Line Connector.

B. Device location

- ① The filter or softener should be located close to drain.
- ② Ensure the unit is installed in enough space for operating and maintenance.
- ③ Brine tank need to be close to softener.
- ④ The unit should be kept away the heater, and not be exposed outdoor. Sunshine or rain will cause the system damage.
- ⑤ Please avoid to install the system in one Acid/Alkaline, Magnetic or strong vibration circumstance, because above factors will cause the system disorder.
- ⑥ Do not install the filter or softener, drain pipeline in circumstance which temperature may drop below 5°C, or above 50°C.
- ⑦ One place is recommended to install the system which cause the minimum loss in case of water leaking.

C. Seat frame assemble

As the Figure 1-1 shows, take the 8 pieces of stands and foot mats to assemble (See the parts name for P51"5040009 seat frame structure chart")

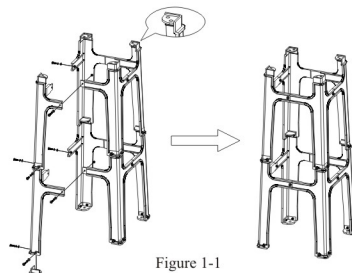

Figure 1-1

D. Pipeline installation (Take 93620 as a sample)**① Install control valve and flow meter**

Figure 1-2

MODEL 53520/53620/63520/63620/73520/73620/93520/93620

- As Figure 1-2 shows, use the 4 pieces of hexagon bolts (M8*25) to install control valve on the seat frame.
- As Figure 1-2 shows, put the sealing ring into flow meter connector, screw in water outlet; insert the sensor into flow meter. (Without this step when the control valve is time clock type)
- As Figure 1-2 shows, when install the brine line connector ball valve and regeneration connector ball valve, it need to put in the sealing ring.
- As Figure 1-2 shows, Insert drain line flow control into drain hose connector, then crew it into drain outlet, and lock it.

② Installing resin tank and top/bottom distributor

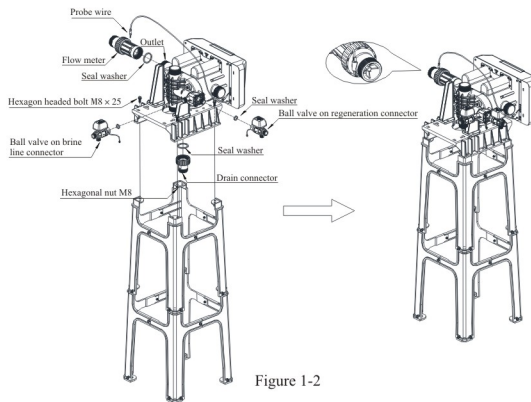
- Fill the mineral to the tank, and the height is accordance with the design code. (The resin is filled up to the top window)
- Top and Bottom distributor pipeline connection is like Figure 1-3, Install a manual ball valve between bottom distributor and tank.

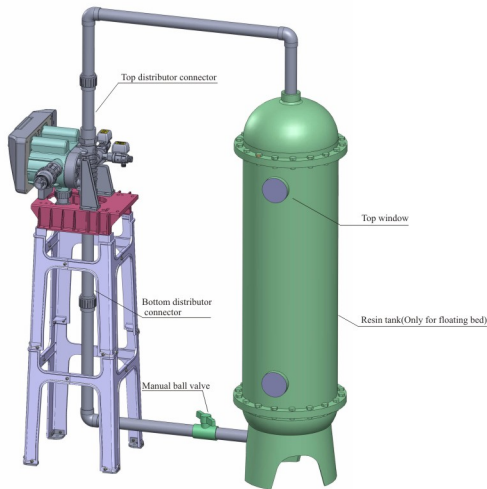

Figure 1-3

MODEL 53520/53620/63520/63620/73520/73620/93520/93620

③ Pipeline connection

- As Figure 1-4 shows, install a pressure gauge in water inlet.
- Install sampling valves in inlet outlet and pipeline A,B,C,D
- Inlet pipeline should be in parallel with outlet pipeline. Support inlet and outlet pipeline with fixed holder.

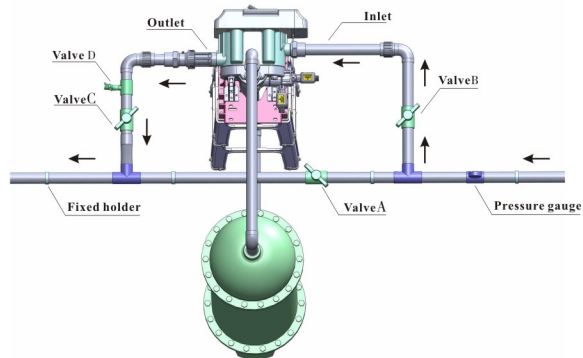

Figure 1-4

Note:

- If making a soldered copper installation, do all sweat soldering before connecting pipes to the valve. Torch heat will damage plastic parts.
- When turning threaded pipe fittings onto plastic fitting, use care not to cross thread or broken valve.

④ Connect brine tube and regeneration pump tube

- As Figure 1-5 shows, use UPVC (DN20) to connect brine valve with brine line connector of control valve.

Note:

- Keep brine line short and smooth. Elbow no more than four to avoid bad brine.
 - Brine valve must be installed.
- As Figure 1-5 shows, use UPVC (DN20) to connect the outlet of regeneration pump with the regeneration connector ball valve, then connect the inlet of regeneration pump with softened water.

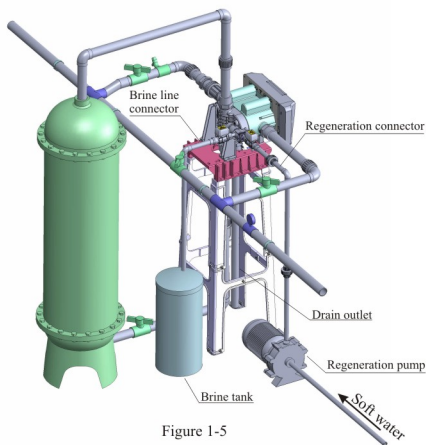

Figure 1-5

© Install drain pipeline

- a. Based on the table on P30, for 93620/93520, if tank diameter is 750 mm, install step d. if the tank size 900 mm you need to ask supplier for injector no. 7702 and relative DLFC. Install it as below steps.
- b. The injector 7701 switch to injector 7702
- c. According to matched tank diameter size, to drill hole on the corresponding quantity of DLFC.
- d. Insert drain line flow control into drain hose connector, then screw it into drain outlet, and lock it.
- e. Glue the drain outlet with UPVC (DN40). Put drain outlet pipe to sewer as showed in the Figure 1-6.
- f. For filter valve 53620/53520 there is no drain line connector install UPVC (DN50) according to step e.



Figure 1-6

Note:

- Control valve should be higher than drain outlet, and be better not far from the drain hose.
- Be sure not connect drain with sewer, and leave a certain space between them, avoid wastewater be absorbing to the water treatment equipment.

E.63620 pipeline install as showed in Figure 1-7:

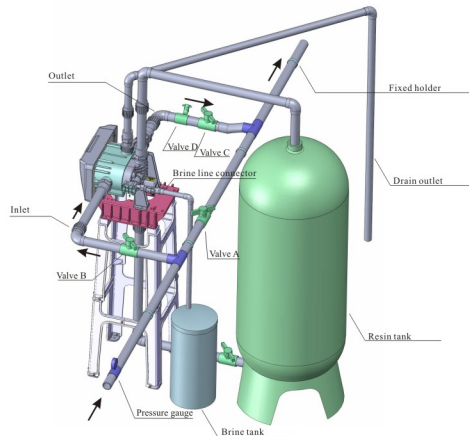
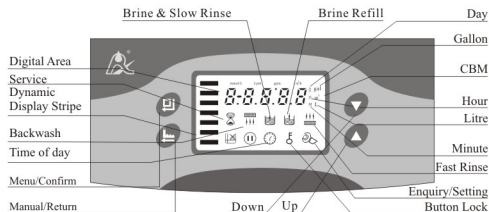

Figure 1-7

2. Basic Setting & Usage

2.1. The Function of PC Board



A. Time of day indicator

Light on, display the time of day.

Light flash, remind you to reset the time of day if electrical service interrupted 3 days more (If electrical service interrupted within 3 days, it doesn't need to reset the time.)

B. Button lock indicator

● Light on, indicate the buttons are locked. At this moment, press any single button will not work (No operation in one minute, will light on and lock the buttons.)

● Solution : Press and hold both and for 5 seconds until the light off.

C. Program mode indicator

● Light on, enter program display mode. Use or to view all values.

● Flash, enter program set mode. Press or to adjust values.

D. Manu/Confirm button

● Press , light on, enter program display mode and use or to view all values.

● In program display mode, press , flash, enter program set mode, press or and adjust values.

● Press after all program are set, and then the voice "Di" means all setting are success and return program display mode.

E. Manual/Return button

● Press in any status, it can proceed to next step.(Example: Press in Service status, it will start regeneration cycles instantly; Press while it is in Backwash status, it will end backwash and go to Brine & Slow Rinse at once.)

● Press in program display mode, and it will return in Service; Press in program

set mode, and it will return program display mode.

● Press while adjusting the value, then it will return program display mode directly without saving value.

F. Down and Up

● In program display mode, press or to view all values.

● In program set mode, press or to adjust values

● Press and hold both and for 5 seconds to lift the Button Lock status.

2.2. Basic Setting & Usage

A. Parameter specification

Function	Indicator	Factory Default	Parameter set range	Instruction
Time of Day		Random	00:00~23:59	Set the time of day when use: " : " flash.
Control Mode	A-01	A-01	A-01	Regenerate on the day although the available volume of treated water drops to zero (0). Regeneration starts at the regeneration time.
			A-02	Regenerate immediately when the available volume of treated water drops to zero(0).
			A-03	Meter Delayed Regeneration type, but by setting Resin Volume, Feed Water Hardness, Regeneration Factor, the controller will calculate the System Capacity. Regeneration mode same as A-01.
			A-04	Meter Immediately Regeneration Type, but by setting Resin Volume, Feed Water Hardness, Regeneration Factor, the controller will calculate the System Capacity. Regeneration mode same as A-02.
Service Days		1-03D	0~99 Days	Only for Time Clock Type, regeneration by days
Regeneration Time	02:00	02:00	00:00~23:59	Regeneration time ; " : " light on
Resin Volume	500	500	20-2000	Resin volume in brine tank (L)
Feed Water Hardness	Ydl.2	1.2	0.1-30.0(9.9)	Feed water hardness (mmol/L)
Exchange Factor	AL.65	0.65	0.30 - 0.99	Relate to the raw water hardness. When hardness is higher, the factor is smaller.
Water Treatment Capacity		200	0-9999.9	Water treatment capacity in one circle (m ³)
Settling bed		10:00	0~99.59	Settling bed time (min:sec)
Backwash Time		10:00	0~99.59	Backwash time (min:sec)
Brine & Slow Rinse Time		60:00	0~99.59	Brine & Slow rinse time (min:sec)

Brine Refill Time		05:00	0~99, 59	Brine refill time (min:sec)
Fast Rinse Time		10:00	0~99, 59	Fast rinse time (min:sec)
Maximum Interval Regeneration Days	H:30	30	0~40	Regenerate on the day even through the available volume of treated water do not drop to zero (0).
Output Control Mode	b-01	01	01 or 02	Mode 01: Signal turn on start of regeneration and shut off end of regeneration. (Connection refer to the Figure on P3) Mode 02: Signal available only intervals of regeneration cycles and in service. (Connection refer to the Figure on P3)

B. Process Display (in order to 93620 A-01 as an example)



Figure A



Figure B

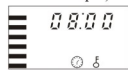

Figure C



Figure D



Figure E



Figure F



Figure G



Figure H

Illustration

● In Service status, the figure shows A/B/C/D; In Settling Bed status, it shows figure E/C; In Brine & Slow Rinse status, it shows F/C; In Brine Refill status, it shows figure G/C; In Fast Rinse status, it shows figure H/C. In each status, every figure shows 15 seconds.

● Above displays are taking the Meter Type for example. For the Time Clock Type, it shows the rest days or hours, such as 1-03D.

● The display screen will only show "-00-" when the electrical motor is running.

● The time of day figure " " flash continuously, such as "12: 12" flash, indicates long outage of power. It reminds to reset the time of day.

● The display will show the error code, such as "-E1-" when the system is in error.

● Working process: Service → Settling bed → Brine & Slow Rinse → Brine Refill → Fast Rinse → Service.

C. Usage

After being accomplished installation, parameter setting and trial running, the valve could be put into use. In order to ensure the quality of outlet water can reach the requirement, the user should complete the below works:

① Ensure that there is solid salt all the time in the brine tank in the course of using when this valve is used for softening. The brine tank should be added the clean water softening salts only, at least 99.5% pure, forbidding use the small salt and iodized salt.

② Test the outlet water and raw water hardness at regular time. When the outlet water hardness is unqualified, please press the and the valve will temporary regenerate again (It will not affect the original set operation cycle.)

③ When the feed water hardness change a lot, you can adjust the water treatment capacity as follow:

Press and hold both and for 5 seconds to lift the lock status. Press , and the light on, then press , the digital area show the control mode. If it shows A-01 or A-02, press three times, and the digital area will show the given water treatment capacity (If the control mode shows A-03 or A-04, then press four times, the digital area will show the feed water hardness); Press again, and digital flash. Press or continuously, reset the capacity value (Or water hardness). Press and hear a sound "Di", then finish the adjustment. Press exit and turn back the service status.

The estimation of water treatment capacity, you can refer to the professional application specification. When select A-03 or A-04 intelligent control mode, the control will automatically calculate the water treatment capacity by setting resin volume, feed water hardness and regeneration factor.

④ For A-01 or A-03 control mode (Delayed regeneration type), please pay attention to whether the time is current or not. If the time is not right, you can adjust as follow: After lifting the lock status, press , the and light on. Then press , the and hour value flashes. Press or continuously, reset the hour value; Press again, and minute value flash. Press or continuously, reset the minute value; Press and hear a sound "Di", then finish the adjustment. Press exit and turn back the service status.

The regeneration parameters have been set when control valve left factory. Generally, it does not need to reset. If you want enquiry and modify the setting, you can refer to the professional application specification.

3. Applications

3.1. Flow Chart

93620/93520 Floating bed flow chart

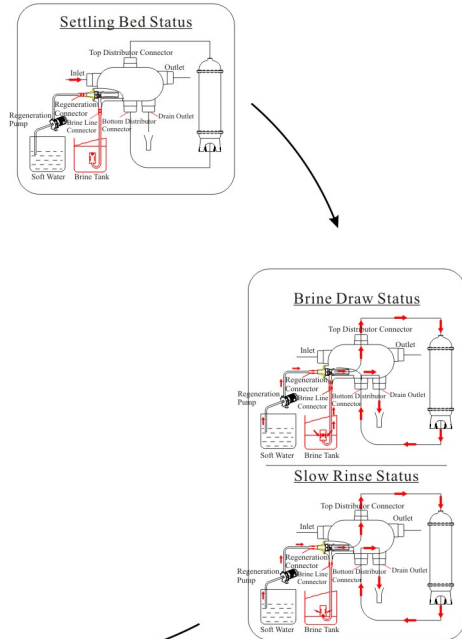
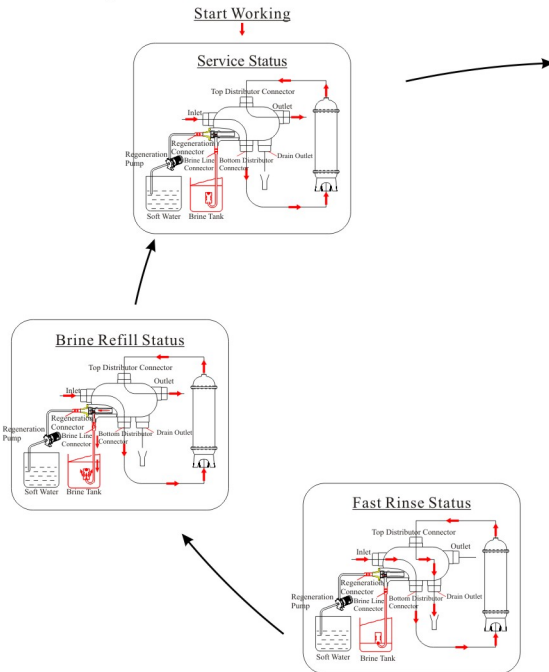

63620/63520 Fixed bed down-flow regeneration and 73620/73520 fixed bed up-flow regeneration flow chart.

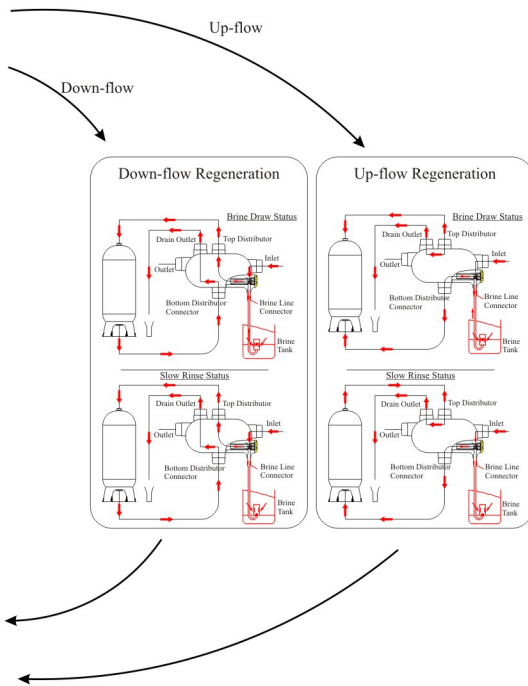
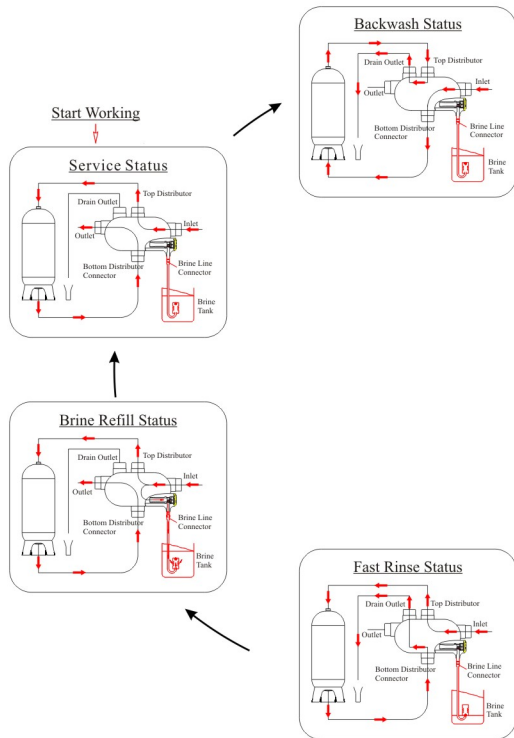

Remark: 53620/53520 Filter valve, only has service, backwash and fast rinse.

3.2. The Function and Connection of PC Board

Open the front cover of control valve, you will see the main control board and connection port as below:

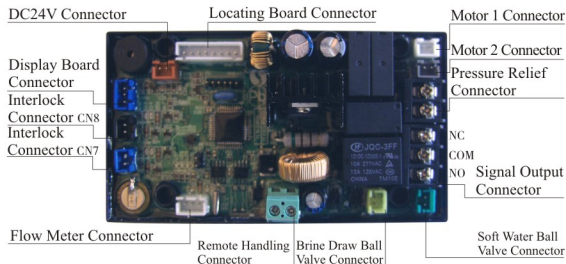

Functions on PC board:

Function	Application	Explanation
Signal output connector b-01	Outlet solenoid valve	If system strictly require no hard water flow from outlet or controlling the liquid level in water tank.
	Inlet pump	Increase pressure for regeneration or washing. Use the liquid level controller to control inlet pump to ensure there is water in tank.
Signal output connector b-02	Inlet solenoid valve or inlet pump	When inlet pressure is high, it needs to close water inlet when valve is rotating to protect motor.
Pressure relief connector	Control the inlet bypass to release pressure	When valve is rotating, pressure relief connector opened to prevent pressure increasing rapidly.
Interlock connector	To ensure only one control valve regeneration or washing in system.	Use in RO Pre-treatment, water supply together but regeneration in turn. Second grade ion exchange equipment, etc.
Remote handling connector	Receipt signal to make the control rotate to next circle	It is used for on-line inspection system, PC connection, and realize automatically or remote controlling valve.

A. Signal Output Connector

1) Control Solenoid Valve (Set b-01)

①Solenoid valve on outlet controls water level in brine tank.
 Instruction: If system strictly require no hard water flow from outlet in regeneration cycle(Mainly for no hard water flow out when valve is switching or valve in backwash or brine drawing positions), a solenoid valve could be installed on outlet, the wiring refer to Figure 3-1.

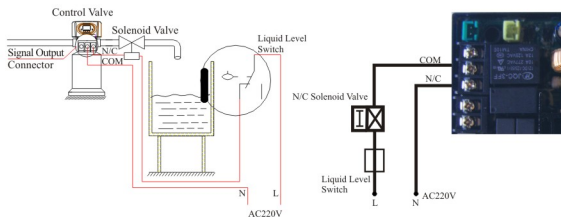

Figure 3-1 Wiring of Solenoid Valve on Outlet

Function:

When valve in service status, if soft water tank is short of water, solenoid valve is open to supply soft water, but if water tank has enough water, solenoid valve is closed, so no soft water supplied.

When the valve in backwash status, there is no signal output. So, solenoid valve is closed, and now water flow into soft water tank.

②Solenoid valve on inlet (Set b-02)

Instruction: When inlet pressure exceeds 0.6MPa, install a solenoid valve on inlet. Control mode is b-02. Pressure relieved when valve switching, the wiring refer to Figure 3-2. As Figure 3-3 shows, it also can use the pressure relief port to work.

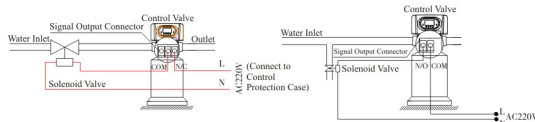

Figure 3-2 Wiring of Solenoid Valve Inlet Figure 3-3 Wiring of Pressure Relief Port

Instruction:

When inlet pressure is high, install a solenoid valve on inlet to ensure valve switching properly. When valve is exactly at position of Service, Backwash, Brine& Slow Rinse, Brine Refill and Fast Rinse, solenoid valve is open. When valve is switching, solenoid valve is closed, no water flow into valve to ensure valve switching properly. It could prevent the problem of mix water and water hammer.

Use interlock cable to realize valves in parallel and series in same system which is suited for RO pretreatment system or second grade Na+ system. The Wiring refer to Figure 3-4:

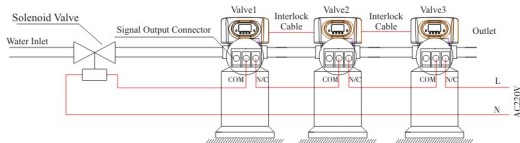

Figure3-4 Wiring of Solenoid Vale in Inlet

2)Liquid Level Controller Controls Inlet Pump(Two-phase motor)(Set b-01)

Instruction: For the system using well or middle-tank supplying water, switch of liquid level controller and valve together control pump opening or closing. The wiring refers to Figure 3-5:

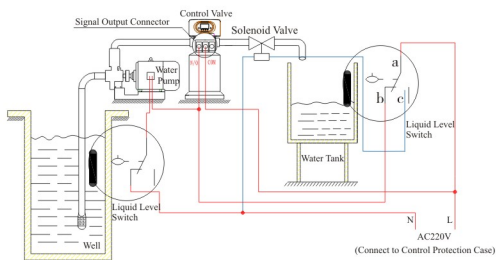

Figure3-5 Wiring of Liquid Level Controller Controlling 220V Inlet Pump

Function:

When valve in service status, if water tank is short of water, start up pump, but if water tank has enough water, the switch of liquid level controller is closed, so pump doesn't work.

When valve in regeneration cycle, inlet always has water no matter what is water condition in water tank. As Runxin valve no water pass outlet in regeneration cycle, it ensure no water fill into brine tank.

A liquid switch at the top opening O well or in middle water tank in RO system protect pump from working without water in case of out of raw water.

3)Liquid Level Switch in Water Tank Controls Inlet Pump (Three-phase) (Set b-01)

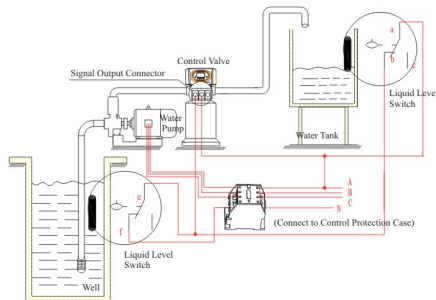

Figure 3-6 wiring of liquid Level Switch in Water Tank Controls 380V Inlet Pump

4)Control Inlet Booster Pump(Set b-01 or b-02)

Instruction: If inlet water pressure is less than 0.15 MPa, which makes rinse drawing difficult, a booster pump is suggested to be installed on inlet. Control mode b-01. When system in regeneration cycle, booster pump is open, the wiring refer to Figure 3-7.If the booster pump current us bigger than 5A, system need to install an contactor, the wiring refer to Figure 3-8

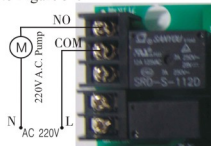

Figure 3-7 Wiring of Booster Pump on Inlet

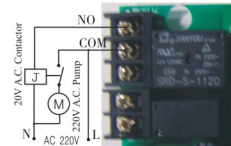

Figure 3-8 Wiring of Booster Pump on Inlet

B. Interlock

Instruction:

In the parallel water treatment system, it ensure only one valve in regeneration or washing cycle and (n-1) valves in service, that is, realizing the function of supplying water simultaneously and regenerating individually, the wiring refer to Figure 3-9

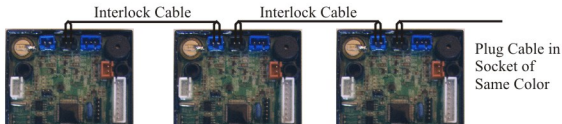

Figure 3-9 Network System Wiring with Interlock Cable

Note: Use Interlock Cable to connect CN8 to CN7 on next valve in the loop.

One system with several valves, if interlock cable is disconnected, the system is divided into two individual system.

C. Pressure Relief Output

Runxin valve will cut off feeding water to drain line when it switches in regeneration cycles. Thus in some water treatment system, e.g. Deep Well, one booster pump was installed on the inlet to increase the system water feeding pressure, this cut-off will cause pressure on inlet rising too fast to damage the valve. Pressure Relief Output can be used to avoid this problem. The wiring refer to Figure 3-10

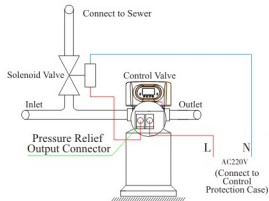

Figure 3-10 Wiring of Pressure Relief Output

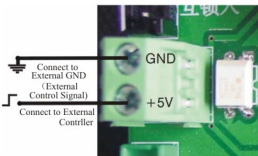

Figure 3-11 Wiring of Remote Input

D. Remote Handling Connector

Online TDS meter monitors treated water other than a flow meter, or PLC controls the regeneration time. When the controller receives a contact closure from above instruments, regeneration begins. The wiring refers to Figure 3-11:

E. Interlock System

2 or more than 2 valves are interlocked connecting in one system and all valves are in service but regenerate individually. The wiring refers to Figure 3-12.

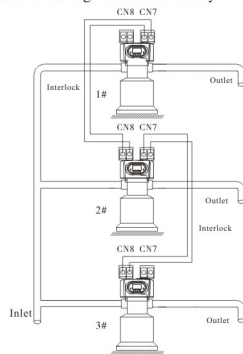

Figure 3-12 Interlock system

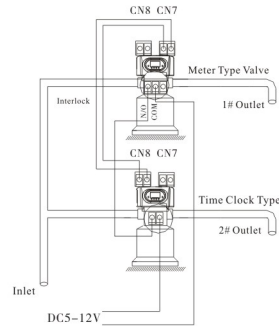

Figure 3-13 Series system

F. Series System

This is a 2 or more than 2 valves system, all in service, with one flow meter for the entire system. For the time type valve, the regeneration time should be set and adjusted to the Max; for the volume type valve, connect its signal output connector with the remote handle connector of the time-type valve. That can realize the function of supplying water simultaneously and regenerating orderly. The wiring refer to Figure 3-13:

G. Inlet pump and soft water pump connecting as Figure 3-14/15/16/17 (Only for 93620 and 93520

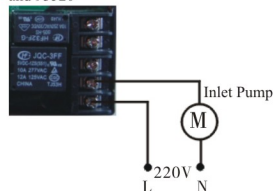

Figure 3-14 Wiring of Inlet Pump Power Less Than 1KW

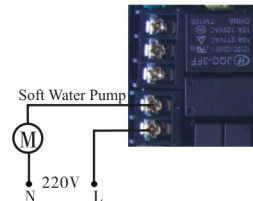

Figure 3-15 Wiring of Soft Water Pump Power Less Than 1KW

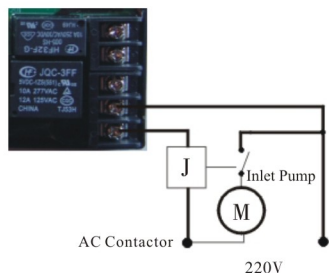

Figure3-16 Wiring of Inlet Pump Power More Than 1KW

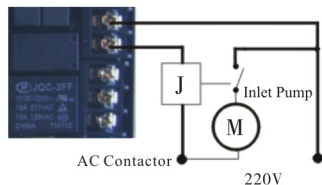

Figure3-17 Wiring of Soft Water Pump Power More Than 1KW

3.3. System Configuration and Flow Rate Curve

A. Product Configuration

Softener valve for floating bed configuration with tank, resin volume, brine tank and injector.

Tank Size (mm)	Resin Volume (L)	Flow Rate (t/h)	Brine Tank Size (mm)	The Minimum Salt Consumption for Regeneration (Kg)	Injector Model
φ 750 × 2400	925	19.9	φ 960 × 1395	92.50	7701
φ 900 × 2400	1330	28.6	φ 1080 × 1460	133.00	7702

Attention: The flow rate calculation is based on linear velocity 45m/hr; the minimum salt consumption for regeneration calculation is based on salt consumption 100g / L (Resin).

Fixed bed softener valve configuration with tank, resin volume, brine tank and injector.

Tank Size (mm)	Resin Volume (L)	Flow Rate (t/h)	Brine Tank Size (mm)	The Minimum Salt Consumption for Regeneration (Kg)	Injector Model
φ 900 × 2400	900	16.0	φ 1080 × 1460	135.00	7703
φ 1000 × 2400	1100	20.0	φ 1240 × 1575	165.00	7704
φ 1200 × 2400	1500	28.0	φ 1360 × 1690	225.00	7705

Attention: The flow rate calculation is based on linear velocity 25m/hr; the minimum salt consumption for regeneration calculation is based on salt consumption 150g / L (Resin).

Filter Valve configuration with tank, resin volume, brine tank and injector.

Tank Size	Filter Material	Active Carbon Filter		Sand Filter	
		Service Flow Rate	Backwash Flow Rate	Service Flow Rate	Backwash Flow Rate
mm	L	m ³ /h	m ³ /h	m ³ /h	m ³ /h
φ 750 × 1800	450	5.3	15.9	11	23.8
φ 900 × 2400	900	7.6	22.9	15.9	34.3

Attention: The activated carbon filter meter is based on linear velocity 12m/hr; the backwashing meter is based on intensity 10L/(m²*s); The sand filter meter is based on linear velocity 25m/h;the backwashing meter is based on intensity 15L/(m²*s).

MODEL 53520/53620/63520/63620/73520/73620/93520/93620

B. Flow Rate Characteristic
1) Pressure-flow Rate Curve
Floating Bed 93620/93520:

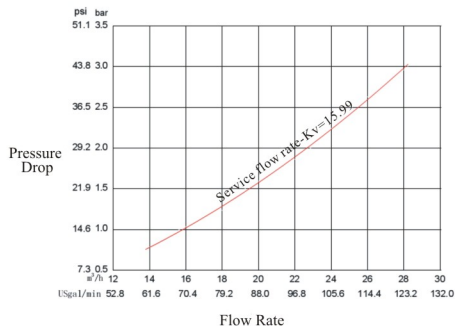

Fixed bed 63620/63520/73620/73520 :

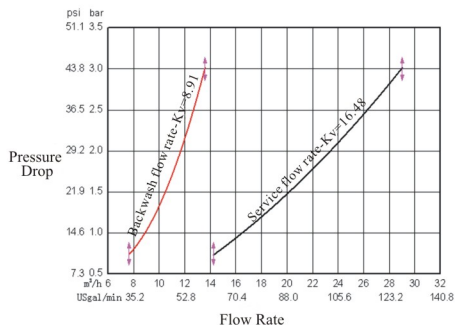

MODEL 53520/53620/63520/63620/73520/73620/93520/93620

2) Injector Parameter Table
Floating Bed 93620/93520:

Regeneration Connector Pressure	Draw Rate (L/M)	
	MPa	
0.16	7701Coffee	7702Pink
	31.4	36.2

Regeneration pump parameter: Rated rate: 2t/h; Rated lift 25m; Rated power 0.75kw; Rated speed 2850; Rated voltage 220V.

Fixed bed 63620/63520/73620/73520 :

Inlet Pressure	Draw Rate (L/M)		
	MPa	7703 Yellow	7704Blue
0.20	45.84	52.90	63.57
0.25	51.50	59.20	71.65
0.30	55.32	63.59	79.54
0.35	60.10	67.73	84.80
0.40	64.36	75.20	8.25

3) Configuration for Standard Injector and Drain Line Flow Control Floating Bed 93620/93520 :

Tank Dia. mm	Injector Model	Injector Color	Draw Rate	Slow Rinse	Brine Refill	DLFC& Holes Quantity	Fast Rinse
			L/m	L/m	L/m		t/h
750	7701	Coffee	31.4	20.6	39.7	0	9.2
900	7702	Pink	36.2	24.1	40.1	1 × φ6	10.8

Fixed bed 63620/63520/73620/73520 :

Tank Dia. mm	Injector Model	Injector Color	Draw Rate	Slow Rinse	Brine Refill	DLFC& Holes Quantity	Backwash/ Fast Rinse
			L/m	L/m	L/m		t/h
900	7703	Yellow	55.32	36.67	77.4	1 × φ6	9
1000	7704	Blue	63.59	46.67	72.7	3 × φ6	12
1200	7705	White	79.54	51.67	80.6	6 × φ6	17

Remark:

- Above data for the product configuration and relevant characteristics are only for reference. When put in practice, please subject to the different requirements of raw water hardness and application.
- Above parameter is tested under 0.3MPa inlet pressure.
- Holes quantity is the holes number on DLFC. Diameter of hole is $\phi 6$, the number refer to above table.
- Injector 7701, 7702, 7703, 7704, 7705, corresponding part no.:5468017, 5468018, 5468018, 5468020, 5468021.

3.4. Parameter settlement**① Service time T1**

$$\text{Water treatment capacity: } Q = V_R \times K \div Y_D \quad (\text{m}^3)$$

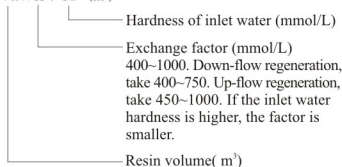

$$\text{By days: } T1 = Q + Q_d \quad (\text{day})$$

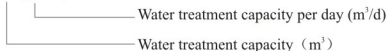
**② Backwash time T2**

It is subject to the turbidity of inlet water. Generally, it is suggested to be set 10-15 minutes. The higher the turbidity is, the longer backwash time can be set. However, if the turbidity is more than 5 FTU, it should be better to install a filter in front of the exchanger.

③ Brine & slow rinse time T3

$$T3 = (40-50) \times Hr \quad (\text{min.})$$

Generally, $T3 = 45Hr$ (min.)

In this formula, Hr — The height of resin in exchange tank (m.)

④ Brine refill time T4

$$\text{Down-flow regeneration: } T4 = 0.45 \times V_R \div \text{Brine refill speed (min.)}$$

$$\text{Up-flow regeneration: } T4 = 0.34 \times V_R \div \text{Brine refill speed (min.)}$$

In this formula, V_R — Resin volume (m³)

The Brine refill speed is related to inlet water pressure. It is suggested to lengthen 1-2 minutes of calculated brine refilling time to make sure there is enough water in tank.

(The condition is that there is a level controller installed in the brine tank)

⑤ Fast rinse time T5

$$T5 = 12 \times HR \quad (\text{min.})$$

Generally, the water for fast rinse is 3-6 times of resin volume. It is suggested to be set 10-16 minutes, but subject to the outlet water reaching the requirement.

⑥ Exchange factor

$$\text{Exchange factor} = E / (k \times 1000)$$

In this formula, E — Resin working exchange capability (mol/m³), it is related to the quality of resin. Down-flow regeneration, take 800-900. Up-flow regeneration, take 900-1200.

K — Security factor, always take 1.2-2. It is related to the hardness of inlet water: the higher the hardness is, the bigger the K is.

⑦ Regeneration time

The whole cycle for generation is about two hours. Please try to set up the regeneration time when you don't need water according to the actual situation.

The calculation of parameters for each step is only for reference, the actual proper time will be determined after adjusting by water exchanger supplier. This calculation procedure of softener is only for industrial application; it is not suitable for small softener in residential application.

3.5. Parameter Enquiry and Setting

3.5.1. Parameter Enquiry

When light on, press and hold both and for 5 seconds to lift the button lock status; then press and light on, enter to program display mode; press or to view each value according to below process.(Press exit and turn back to service status)

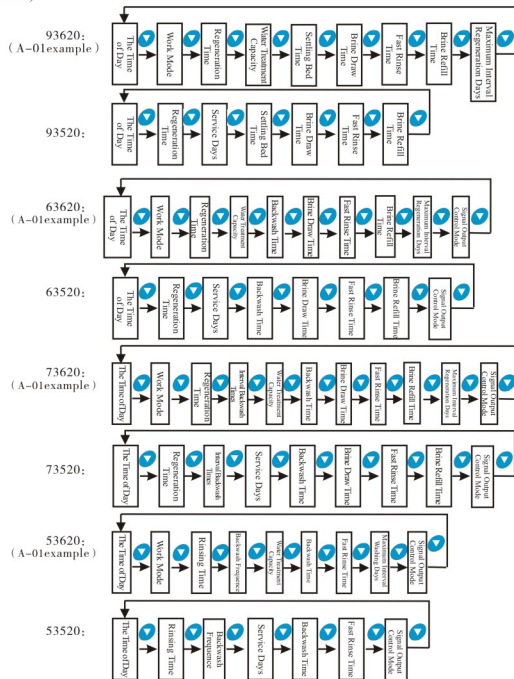

3.5.2. Parameter Setting(Take 93620 A-01 as example)

In program display mode, press and enter into program set mode. Press or to adjust the value.

3.5.3. The Steps of Parameter Setting

Items	Process steps	Symbol
Time of Day	<p>When time of day "12:12" continuously flash, it reminds to reset;</p> <ol style="list-style-type: none"> 1. Press to enter into program display mode; both and symbol light on, ":" flash; Press , both and hour value flash, through or to adjust the hour value; 2. Press again, both and hour value flash, through or to adjust the minute value; 3. Press and hear a sound "Di", then finish adjustment, press to turn back. 	
Control Mode	<ol style="list-style-type: none"> 1. In control mode display status, press and enter into program set mode, and 01 value flash; 2. Press or , set the value to be A-01, A-02, A-03 or A-04 control mode 3. Press and hear a sound "Di", then finish adjustment, press to turn back. 	
Regeneration Time	<ol style="list-style-type: none"> 1.1. In regeneration time display status, press and enter into program set mode. and 02 flash; Press or to adjust the hour value; 2. Press again, and 00 flash, press or to adjust the minute value; 3. Press and hear a sound "Di", then finish adjustment, press to turn back. 	
Water Treatment Capacity	<ol style="list-style-type: none"> 1. In water treatment capacity display status, it shows and 200.00. Press and enter into program set mode. and 200.00 flash; 2. Press or to adjust the water treatment capacity value (m³); 3. Press and hear a sound "Di", then finish adjustment, press to turn back. 	

Settling bed Time	<p>1. In Settling bed time display status, shows and 2-10 : 00, Press and enter into program set mode, and 10 flash; Press and , modify the Settling bed minute time;</p> <p>2. Press , and :00 flash, Press and , modify the Settling bed second time;</p> <p>3. Press and hear a sound “Di”, then finish adjustment, press to turn back.</p>	
Brine& Slow Rinse Time	<p>1. In brine& slow rinse time display status, it shows and 3-60 Press and enter into program set mode. and 60 flash;</p> <p>2. Press or to adjust the brine time;</p> <p>3. Press and hear a sound “Di”, then finish adjustment, press to turn back.</p>	
Fast Rinse Time	<p>1. In fast rinse time display status, it shows and 4-10. Press and enter into program set mode. and 10 flash;</p> <p>2. Press or to adjust the fast rinse time;</p> <p>3. Press and hear a sound “Di”, then finish adjustment, press to turn back.</p>	
Brine Refill Time	<p>1. In brine refill time display status, it shows and 5-05:00, Press and enter into program set mode. and 05 flash;</p> <p>2. Press or to modify the brine refill time;</p> <p>3. Press and hear a sound “Di”, then finish adjustment, press to turn back.</p>	
Maximum Interval Regeneration Days	<p>1. In maximum Interval regeneration days display status, it shows H-30. Press and enter into program set mode. and 30 flash;</p> <p>2. Press or to adjust the Interval regeneration days;</p> <p>3. Press and hear a sound “Di”, then finish adjustment, press to turn back.</p>	

For example, the fast rinse time of a softener is 12 minutes. After regenerating, the chloridion in the outlet water is always higher than normal, indicating that there is not enough time for fast rinse. If you want the time to set to 15 minutes, the modification steps as follows:

- ① Press and hold both and to lift the button lock status (light off) ;
- ② Press , and light on;
- ③ Press or continuously until light on. Then the digital area shows: 4-12:00M ;
- ④ Press , and 12:00 flash;
- ⑤ Press continuously until 12 changed to 15;
- ⑥ Press , there is a sound “Di” and the figure stop flashing; the program back to enquiry status
- ⑦ If you want to adjust other parameters, you can repeat the steps from ② to ⑤ ; If you don't, press and quit from the enquiry status, the display will show the current service status.



3.6. Trial Running



After installing the multi-functional flow control valve on the resin tank with the connected pipes, as well as setting up the relevant parameter, please conduct the trial running as follows:



A. Close the inlet valve B & C, and open the bypass valve A. After cleaning the foreign materials in the pipe, close the bypass valve A. (as Figure 1-4 shows)



B. Fill the brine tank with the planned amount of water and adjust the air check valve.



Then add solid salt to the tank and dissolve the salt as much as possible.

C. Switch on power. Press  and go in the Backwash position; when  light on (For floating bed, switch valve to Fast Rinse), slowly open the inlet valve B to 1/4 position, making the water flow into the resin tank; you can hear the sound of air-out from the drain pipeline. After all air is out of pipeline, then open inlet valve B completely and clean the foreign materials in the resin tank until the outlet water is clean. It will take 8-10 minutes to finish the whole process.

D. Press  , turning the position from Backwash to Brine & Slow Rinse;  light on and enter in the process of Brine & Slow Rinse. The air check valve close when control valve finished sucking brine, then slow rinse start to work. It is about 60-65 minutes for whole process.

E. Press  to Fast rinse position.  light on. It takes about 10-15 minutes, take out some outlet water for testing: if the water hardness reach the requirement, and the chloridion in the water is almost the same compared with the inlet water, then go to the next step.

F. Press  to Brine refill position.  light on and it indicates the brine tank is being refilled with water to the required level. It takes about 5-6 minutes, then add solid salt to the brine tank.

G. Press  , making the control valve return to Service Status;  light on and start to running.

Note:

● When the control valve enter into the regeneration status, all program can be finished automatically according to the setting time; if you want one of steps terminated early, you can press .

● If water inflow too fast, the media in tank will be damaged. When water inflow slowly, there is a sound of air emptying from drain pipeline.

● After changing resin, please empty air in the resin according to the above Step C.

● In the process of trial running, please check the water situation in all position, ensuring there are no resin leakage.

● The time for Backwash, Brine & Slow Rinse, Brine Refill and Fast Rinse position can be set and executed according to the calculation in the formula or suggestions from the control valve suppliers.

3.7. Trouble-Shooting

A. Control Valve Fault

Problem	Cause	Correction
1. Softener fails to regenerate.	A. Electrical service to unit has been interrupted. B. Regeneration cycles set incorrect. C. Controller is defective. D. Motor fails to work.	A. Assure permanent electrical service (Check fuse, plug, pull chain or switch). B. Reset regeneration cycles. C. Replace controller. D. Replace motor.
2. Regeneration time is not correct.	A. Time of Day not set correctly. B. Power failure more than 3 days.	Check program and reset time of day.
3. Softener supply hard water.	A. Bypass valve is open or leaking. B. No salt in brine tank. C. Injector plugged. D. Insufficient water flowing into brine tank. E. Leak at O-ring on riser pipe. F. Internal valve leak. G. Regeneration cycles not correct. H. Shortage of resin. I. Bad quality of feed water or turbine blocked.	A. Close or repair bypass valve. B. Add salt to brine tank and maintain salt level above water level. C. Change or clean injector. D. Check brine tank refill time. E. Make sure riser pipe is not cracked. Check o-ring and tube pilot. F. Change valve body. G. Set correct regeneration cycles in the program. H. Add resin to mineral tank and check whether resin leaks. I. Reduce the inlet turbidity, clean or replace turbine.
4. Softener fails to draw brine.	A. Line pressure is too low. B. Brine line is plugged. C. Brine line is leaking. D. Injector is plugged. E. Internal control leak. F. Drain line is plugged. G. Sizes of injector and DLFC not match with tank. H. Ball valve or cable failure	A. Increase line pressure. B. Clean brine line. C. Replace brine line. D. Clean or replace new parts. E. Replace valve body. F. Clean drain line flow control. G. Select correct injector size and DLFC according to the P29 requirements. H. Replace ball valve or cable
5. Unit used too much salt.	A. Improper salt setting. B. Excessive water in brine tank.	A. Check salt usage and salt setting. B. See problem no.6.

6. Excessive water in brine tank.	A. Overlong refilling time. B. Foreign material in brine line. C. Foreign material in brine valve and plug drain line flow control. D. Not install safety brine valve but power failure whiling salting. E. Safety brine valve breakdown. F. Ball valve doesn't close	A. Reset correct refilling time. B. Clean brine line. C. Clean brine valve and brine line. D. Stop water supplying and restart pr install safety brine valve in salt tank. E. Repair or replace safety brine valve. F. Close or replace ball valve or cable
7. Pressure lost or iron in conditioned water.	A. Iron in the water supply pipe. B. Iron mass in the softener. C. Fouled resin bed. D. Too much iron in the raw water.	A. Clean the water supply pipe. B. Clean valve and add resin cleaning chemical, increase frequency of regeneration. C. Check backwash, brine draw and brine tank refill. Increase frequency of regeneration and backwash time. D. Iron removal equipment is required to install before softening.
8. Loss of mineral through drain line.	A. Air in water system. B. Bottom strainer broken. C. Improperly sized drain line control.	A. Assure that well system has proper air eliminator control. B. Replace new bottom strainer. C. Check for proper drain rate.
9. Control cycle continuously.	A. Locating signal wiring breakdown. B. Controller is faulty. C. Foreign material stuck the driving gear. D. Time of regeneration steps were set to zero.	A. Check and connect locating signal wiring. B. Replace controller. C. Take out foreign material. D. Check program setting and reset.
10. Drain flows continuously.	A. Internal valve leak. B. When electricity fails to supply, valve stops backwash or rapid rinse position.	A. Check and repair valve body or replace it. B. Adjust valve to service position or turn off bypass valve and restart when electricity supply.
11. Interrupted or irregular brine.	A. Water pressure too low or not stable. B. Injector is plugged or faulty. C. Air in resin tank. D. Floccules in resin tank during backwash.	A. Increase water pressure. B. Clean or replace injector. C. Check and find the reason. D. Clean the floccules in resin tank.

12. Water flow out from drain or brine pipe after regeneration.	A. Foreign material in valve which makes valve can't be closed completely. B. Hard water mixed in valve body. C. Water pressure is too high which result in valve doesn't get the right position. D. Ball valve or cable failure	A. Clean foreign material in valve body. B. Change valve core or sealing ring. C. Reduce water pressure or use pressure release function. D. Replace ball valve or cable
13. Salt water in soften water.	A. Foreign material in injector pr injector fails to work. B. Brine valve cannot be shut-off. C. Time of rapid rinse too short.	A. Clean and repair injector. B. Repair brine valve and clean it. C. Extend rapid rinse time.
14. Unit capacity decreases.	A. Unit fails to regenerate or regenerate not properly. B. Fouled resin bed. C. Salt setting not proper. D. Softener setting not proper. E. Raw water quality deterioration. F. Turbine of flow meter is stuck.	A. Regenerate according to the correct operation requirement. B. Increase backwash flow rate and time, clean or change resin. C. Readjust brine drawing time. D. According to the test of outlet water, recount and reset. E. Regenerate unit by manual temporary then reset regeneration cycle. F. Disassemble flow meter and clean it or replace a new turbine.

B. Controller Fault

Problem	Cause	Correction
1. All indicators display on front panel.	A. Wiring of front panel with controller fails to work. B. Control board is faulty. C. Transformer damaged. D. Electrical service not stable.	A. Check and replace the wiring. B. Replace control board. C. Check and replace transformer. D. Check and adjust electrical service.
2. No display on front panel.	A. Wiring of front panel with controller fails to work. B. Front panel damaged. C. Control board damaged. D. Electricity is interrupted.	A. Check and replace wiring. B. Replace front panel. C. Replace control board. D. Check electricity.

3. E11 Flash	<p>A. Wiring of locating board with controller fails to work. B. Locating board damaged. C. Mechanical driven failure. D. Faulty control board. E. Wiring of motor with controller is fault. F. Motor 2 damaged.</p>	<p>A. Replace wiring. B. Replace locating board. C. Check and repair mechanical part. D. Replace control board. E. Replace wiring. F. Replace motor 2.</p>
4. E21 Flash	<p>A. Wiring of locating board with controller fails to work. B. Locating board damaged. C. Mechanical driven failure. D. Faulty control board. E. Wiring of motor with controller is fault. F. Motor 2 damaged.</p>	<p>A. Replace wiring. B. Replace locating board. C. Check and repair mechanical part. D. Replace control board. E. Replace wiring. F. Replace motor 2.</p>
5. E12 or E22 Flash	<p>A. Hall component on locating board damaged. B. Wiring of locating board with controller fails to work. C. Control board is faulty.</p>	<p>A. Replace locating board. B. Replace wiring. C. Replace control board.</p>
6. E3 or E4 Flash	A. Control board is faulty.	A. Replace control board.

3.8. Assembly & Parts
93620 exploring drawing

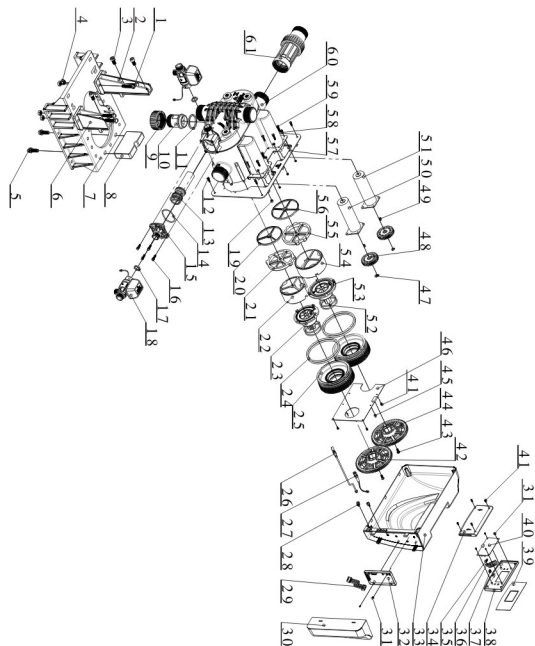

MODEL 53520/53620/63520/63620/73520/73620/93520/93620

93520 Assembly & Parts:

Item No.	Description	Part No.	Quantity	Item No.	Description	Part No.	Quantity
1	Hexagon Head Bolts M10×40	5851010	4	32	Control Board	6382049	1
2	Fixed Part	8109043	1	33	Dust Cover	8005037	1
3	Hexagon Head Bolts M10×16	8902046	3	34	Board Back Cover	5300003	1
4	Hexagon Nut	8940023	4	35	Cable Clip	8126001	1
5	Hexagon Head Bolts M10×35	5851001	2	36	Tree-core Spring	5517001	1
6	Fixed Part	8109073	1	37	Bushings	8126006	1
7	Fixed Part	8109060	1	38	Board Front Cover	8300013	1
8	Fixed Part	8109075	1	39	Label	8865011	1
9	Animated Connector	8947005	1	40	Display Board	6381007	1
10	Brine Line Flow Control	8468012	1	41	Screw, Cross ST2.9 × 9.5	8909008	14
11	Seal Ring	8371008	1	42	Gear	5241017	1
12	Screw, Cross ST3.9 × 13	8909016	13	43	Screw, Cross ST4.8 × 19	8909018	2
13	Injector	5468017	1	44	Gear	5241018	1
14	O-ring 52 × 3	8378096	1	45	Pin 2.5 × 12	8993004	2
15	Injector Cover	8315030	1	46	Locating Board	6380027	1
16	Hexagon Head Bolts M5 × 20	5851006	4	47	Locking Ring	8994009	2
17	Seal Ring	8371019	2	48	Small Gear	5241008	2
18	Electric Ball Valve	2976064	2	49	Button C4 × 12	8971001	2
19	Hexagonal Nut	8940002	4	50	Motor	6158038	1
20	Seal Ring	8370079	1	51	Motor	6158039	1

MODEL 53520/53620/63520/63620/73520/73620/93520/93620

21	Fixed Disk	8469052	1	52	O-ring 59.92 × 3.53	8378110	4
22	Moving Disk	8459051	1	53	Shaft	8258027	1
23	Shaft	8258005	1	54	Fixed Disk	8459052	1
24	O-ring 123.19 × 5.33	8378161	4	55	Moving Disk	8469053	1
25	Pressure Nut	8092035	2	56	Seal Ring	8370079	1
26	Probe Wire	6386010	1	57	Junction Plate	8152019	1
27	Wire for Power	5513001	1	58	Screw, Cross M4×12	8902005	4
28	Toggle	8126004	2	59	Screw, Cross M4×25	8902008	8
29	Wire for Locating Board	5511016	1	60	Valve Body	5022059	1
30	Front Cover	8300032	1	61	Flow Meter	5447003	1
31	Screw, Cross ST2.2 × 6.5	8909004	8	62			

Note :

93520 Assembly & Parts: the Item No. 26, 61 is only for 93620.

63620 exploring drawing:

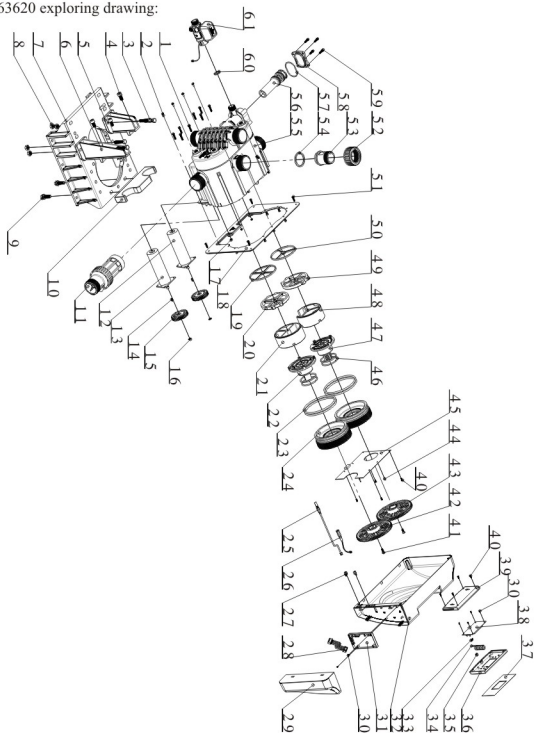

63620 Assembly & Parts :(Item No.55 for Valve Body Part No. is 5022058)

Item No.	Description	Part No.	Quantity	Item No.	Description	Part No.	Quantity
1	Screw, Cross M4×25	8902008	8	32	Dust Cover	8005037	1
2	Screw, Cross M4×12	8902005	4	33	Cable Clip	8126001	1
3	Hexagon Head Bolts M10×40	5851010	4	34	Three-core Spring	5517001	1
4	Screw, Cross M10×16	8902046	3	35	Bushings	8126006	1
5	Fixed Part	8109073	1	36	Board Front Cover	8300013	1
6	Fixed Part	8109043	1	37	Label	8865011	1
7	Fixed Part	8109060	1	38	Display Board	6381007	1
8	Hexagon Nut	8940023	4	39	Board Back Cover	5300003	1
9	Hexagon Head Bolts M10×35	5851001	2	40	Screw, Cross ST2.9×9.5	8909008	14
10	Fixed Part	8109074	1	41	Screw, Cross ST4.8×19	8909018	2
11	Flow Meter	5447003	1	42	Gear	5241018	1
12	Motor	6158038	1	43	Gear	5241017	1
13	Motor	6158039	1	44	Pin 2.5×12	8993004	2
14	Button C4×12	8971001	2	45	Locating Board	6380027	1
15	Small Gear	5241008	2	46	O-ring 59.92×3.53	8378110	4
16	Locking Ring	8994009	1	47	Locking Ring	8258005	1
17	Hexagon Nut	8940002	4	48	Moving Disk	8459051	1
18	Junction Plate	8152019	1	49	Fixed Disk	8469051	1
19	Seal Ring	8370079	1	50	Seal Ring	8370078	1

MODEL 53520/53620/63520/63620/73520/73620/93520/93620

20	Fixed Disk	8469053	1	51	Screw, Cross ST3.9 x 16	8909016	13
21	Moving Disk	8459052	1	52	Animated Connector	8947005	1
22	Shaft	81258027	1	53	Brine Line Flow Control	8468049	1
23	O-ring 123.19 x 5.33	8378161	4	54	Seal Ring	8371008	1
24	Pressure Nut	8092035	2	55	Valve Body	5022058	1
25	Probe Wire	6386001	1			5022059	1
26	Wire for Power	5513001	1	56	Injector	5468020	1
27	Toggle	8126004	2	57	O-ring 52 x 3	8378096	1
28	Wire for Locating Board	5511016	1	58	Injector Cover	8315007	1
29	Front Cover	8300032	1	59	Hexagon Bead Bolts M5x20	5851006	4
30	Screw, Cross ST2.2 x 6.5	8909004	8	60	Seal Ring	8371019	1
31	Control Board	6382049	1	61	Electric Ball Valve	2976064	1

Note:

63520 Assembly & Parts: Item No. 11, 25 only for 63620.

53620 Assembly & Parts: Item No. 52, 53, 54, 60,61 only for 63620, But increase one piece seal ring 8371019 and one piece blind nut 8940004.

53520 Assembly & Parts: Item No.60,61,11,25 only for 63620, But increase one piece seal ring 8371019 and one piece blind nut 8940004.

73620 Assembly & Parts: Item No.55 for Valve Body Part No. 5022059, and the remaining parts same to 63620.

73520 Assembly & Parts: Item No.55 for Valve Body Part No. is 5022059, and the remaining parts same to 63520.

MODEL 53520/53620/63520/63620/73520/73620/93520/93620

5447003 Flow meter:

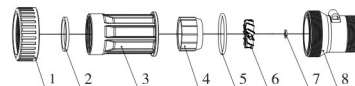

5447003 Flow Meter Components:

Item No.	Description	Part No.	Quantity	Item No.	Description	Part No.	Quantity
1	Animated Connector	8947004	1	6	Turbine	5436005	1
2	Seal Ring	8371008	1	7	Rotator	8210002	1
3	Connector	8458016	1	8	Flow Meter Shell	5002002	1
4	Fixed Connector	8109006	1				
5	O-ring 60X4	8378137	1				

5040009 Seat frame exploring drawing:

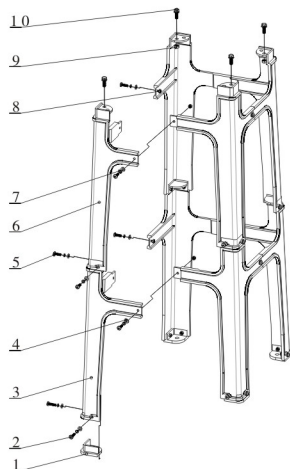

5040009 Seat frame Assembly & Parts:

Item No.	Description	Part No.	Quantity	Item No.	Description	Part No.	Quantity
1	Foot Mat	8156002	4	6	Stand	8040031	4
2	Screw, Cross ST M6 × 25	8902039	8	7	Locking Ring	8953001	24
3	Stand	8040030	4	8	Hexagon Nut	8940020	24
4	Flat Pad	8952007	24	9	Hexagon Nut	8940021	4
5	Screw, Cross ST M6 × 20	8902038	16	10	Hexagon Head Bolts	5851002	4

4. Warranty Card

Dear client:

This warranty card is the guarantee proof of RUNXIN brand multi-functional flow control valve. It is kept by client self. You could get the after-sales services from the supplier which is appointed by RUNXIN manufacturer. Please keep it properly. It couldn't be retrieved if lost. It couldn't be repaired free of charge under the below conditions:

1. Guarantee period expired.(One year);
2. Damage resulting from using, maintenance, and keeping that are not in accordance with the instruction;
3. Damage resulting from repairing not by the appointed maintenance personnel;
4. Content in guarantee proof is unconfirmed with the label on the real good or be altered;
5. Damage resulting from force majeure.

Product Name	 Multi-functional Flow Control Valve for Water Treatment Systems		
Model			Code of Valve Body
Purchase Company Name			Tel./Cel.
Problem			
Solution			
Date of Repairing	Date of Accomplishment	Maintenance Man Signature	

When product need warranty service, please fill in the below content and send this card together with the product to the appointed suppliers or Runxin company.

End-user Company Name			Tel./Cel.	
Purchase Company Name			Tel./Cel.	
Model	Code of Valve Body			
Tank Size ϕ ×	Resin Tank Size	L	Raw Water Hardness	mmol/L
Water Source: Ground-water <input type="checkbox"/> Tap Water <input type="checkbox"/>	Water Treatment Capacity	m ³	Backwash Time	min
Brine & Slow Rinse Time	min	Brine Refill Time	min	Fast Rinse Time
Problem Description				