



## Multi-functional Flow Control Valve for Water Treatment Systems

17610/17606 (One in service and one standby fixed bed system)  
93610/93606(One in service and one standby floating bed system)



## Instruction Manual

Please read this manual in details  
before using this valve and keep it properly  
in order to consult in the future

0WRX.466.539

### WENZHOU RUNXIN MANUFACTURING MACHINE CO.,LTD

ADD: Jinger Road, Shatou Group, Linjiang, Lucheng District, Wenzhou, Zhejiang, China

Tel: +86-577-88635628 88630038 Fax: +86-0577-88633258

Http://www.run-xin.com Email:sales@run-xin.com



Before the valve put into use, please fill in the below content so as to help us to refer in the future.

**Softener System Configuration**

Tank Size: Dia. \_\_\_\_\_ mm, Height \_\_\_\_\_ mm;  
 Resin Volume \_\_\_\_\_ L; Brine Tank Capacity \_\_\_\_\_ L;  
 Hardness of Raw water \_\_\_\_\_ mmol/L; Pressure of Inlet Water \_\_\_\_\_ MPa;  
 Control Valve Model \_\_\_\_\_; Number \_\_\_\_\_;  
 The Specification of Brine Line Flow Control \_\_\_\_\_; Injector No. \_\_\_\_\_,  
 Water Source: Ground-water  Filtered Ground-water  Tap Water  Other \_\_\_\_\_.

**Parameter Set**

| Parameter                                 | Unit           | Factory Default | Actual Value |
|---|----------------|-----------------|--------------|
| Time of Day                               | 24:00          | Current time    |              |
| Control Mode A-01/02                      | /              | A-01            |              |
| Backwash Frequency (Only for 17610/17606) | /              | F-00            |              |
| Unit Mode HU-01/02/03                     | /              | HU-01           |              |
| Water Treatment Capacity                  | m <sup>3</sup> | 80.00           |              |
| Resin Volume                              | L              | 50 L            |              |
| Water Hardness                            | mmol/L         | 1.2 mmol/L      |              |
| Regeneration Factor                       | /              | 0.65            |              |
| Fast Rinse Time                           | Min.           | 10              |              |
| Settling Bed Time (Only for 93610/93606)  | Min.           | 10              |              |
| Backwash Time (Only for 17610/17606)      | Min.           | 10              |              |
| Brine Drawing& Slow Rinse Time            | Min.           | 70              |              |
| Brine Refill Time                         | Min.           | 05              |              |
| Interval Regeneration Days                | D              | 30              |              |
| Control Mode b-01(02)                     | /              | b-01            |              |

● If there is no special requirement when product purchase, we choose 3# injector for the standard configuration.

## Catalogue

|   |    |
|---|----|
| Notice.....   | 3  |
| 1. Product Overview.....                            | 4  |
| 1.1.Main Application & Applicability.....           | 4  |
| 1.2.Product Characteristics.....                    | 4  |
| 1.3.Service Condition.....                          | 6  |
| 1.4.Product Structure and Technical Parameters..... | 7  |
| 1.5.Installation.....                               | 10 |
| 2.Basic Setting & Usage.....                        | 13 |
| 2.1.The Function of PC Board.....                   | 13 |
| 2.2.Basic Setting & Usage.....                      | 14 |
| 3.Applications.....                                 | 18 |
| 3.1.Softener Flow Chart.....                        | 18 |
| 3.2.The Function and Connection of PC Board.....    | 20 |
| A. Signal Output Connector.....                     | 21 |
| B. Pressure Relief Output.....                      | 23 |
| C. Remote Handling Connector.....                   | 23 |
| 3.3.System Configuration and Flow Rate Cure.....    | 24 |
| 3.4.Parameter Settlement.....                       | 28 |
| 3.5.Parameter Enquiry and Setting.....              | 29 |
| 3.6.Trial Running.....                              | 33 |
| 3.7.Trouble-Shooting.....                           | 34 |
| 3.8.Assembly & Parts.....                           | 37 |
| 4. Warranty Card.....                               | 44 |

## Notice

- To ensure normal operation of the valve, please consult with professional installation or repairing personnel before use it.
- If there are any of pipeline engineering and electric works, there must be finished by professional at the time of installation.
- Do not use the control valve with the water that is unsafe or unknown quality.
- Depending on the changing of working environment and water requirement, each parameter of softener should be adjusted accordingly.
- When the water treatment capacity is too low, please check the resin. If the reason is shortage of resin, please add; if the resin is turn to reddish brown or broken, please replace.
- Test water periodically to verify that system is performing satisfactorily.
- Ensure that there is solid salt all the time in the brine tank in the course of using, when this valve is used for softening, the brine tank should be added the clean water softening salts only, at least 99.5% pure, forbidding use the small salt.
- Do not put the valve near the hot resource, high humidity, corrosive, intense magnetic field or intense vibrations environment. And do not leave it outside.
- Forbidden to carry the injector body. Avoid to use injector body as support to carry the system.
- Forbidden to use the brine tube or other connectors as support to carry the system.
- Please use this product under the water temperature between 5 ~ 50°C, and water pressure 0.2 ~ 0.6MPa. Failure to use this product under such conditions voids the warranty.
- Control valve for floating bed have higher requirement for water inlet pressure, the pressure is better between 0.2 - 0.3MPa. It is advised to install a regulator valve in the inlet pipeline. If the water pressure exceeds 0.6Mpa, a pressure reducing valve must be installed before the water inlet. While, if the water pressure under 0.2MPa, a booster pump must be installed before the water inlet.
- It is suggested to install PPR pipe, corrugated pipe or UPVC pipe, instead of TTLSG pipe.
- Please use specific resin tank for floating bed and appropriate strainers (Water cap type is preferred). The resin should be filled to 10-15 cm lower than the top strainer.
- Do not let children touch or play, because carelessness operating may cause the procedure changed.
- When the attached cables of this product and transformer are changed, they must be changed to the one that is from our factory.
- Please install a disc filter on the inlet of the control valve.

# 1. Product Overview

## 1. Product Overview

### 1.1. Main Application & Applicability

Used for softening or demineralization water treatment systems

Suit for:

Residential softening system

Ion exchange equipment

Boiler softening water system





RO pretreatment softening system

### 1.2. Product Characteristics

#### ● Simple structure and reliable sealing

It adopts hermetic head faces with high degree pottery and corrosion resistance for opening and closing. It combines with Service, Backwash(Settling Bed), Brine & Slow Rinse, Brine Refill and Fast Rinse.

#### ● One Valve for dual purpose

When you install the valve, set up the drain port toward left it becomes valve 93610 (93606), toward right it becomes valve 17610(17606). When the valve power on, hold and press buttons  and  for 5 seconds can enter the program choice mode, use  or  to select program and then press  to confirm.

#### ● Meter type ,one valve double tank supply water uninterruptedly

#### ● Manual function

Realize regeneration immediately by pushing  at any time.



#### ● Long outage indicator

If outage overrides 3 days, the time of day indicator “12:12” will flash to remind to reset new time of day. The other set parameters do not need to reset. The process will continue to work after power on.

#### ● LED dynamic screen display

The stripe on dynamic screen flash, it indicates the control valve is in service position, otherwise, it is in regeneration cycle.

#### ● Button lock

No operations to buttons on the controller within 1 minute, button lock indicator light on which represents buttons are locked. Before operation, press and hold the  and  buttons for 5 seconds to unlock. This function can avoid incorrect operation.

#### ● Signal output

There is a signal output connector on main control board. It is for controlling external

wiring (Refer to Figure from Figure 3-2 to Figure 3-6).

There are two kinds of output modes. b-01 Mode: Turn on start of regeneration and shut off end of regeneration; b-02 Mode: Signal available only intervals of regeneration cycles and in service. (For valve 93610/93606, the backwash in Figure 1 and Figure 2 shall be settling bed.)

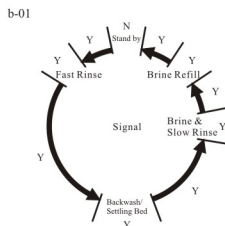

Figure 1 (b-01)

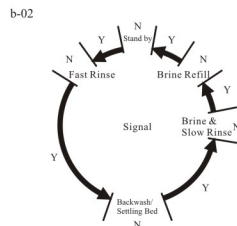

Figure 2 (b-02)

#### ● Remote handling input

This connector can receive external signal, used together with PLC, and computer etc. to control the valve. (Application refer to Figure 3-8)

#### ● Pressure relief output

17610/17606: The valve will cut off feeding water to drain line when it switches in regeneration cycles (Same as signal output b-02). It is usually adopted in system with a boost pump installed on the inlet. When the motor switches position, it releases the pressure between inlet and valve to avoid the water rinsing too fast to damage the valve. (Application refer to Figure 3-7)

93610/93606: Signal is given all the cycle except settling bed status. It is mainly used in pump water supply system. And the signal is only turned off the pump in settling bed status.

#### ● Maximum interval regeneration days

Under the situation of service reaching the setting days and the volume not yet, it could enter into regeneration process forcibly when current time is the same as regeneration time.

#### ● All parameters can be modified

According to the water quality and usage, the parameters in the process can be adjusted.

### 1.3.Service Condition

This valve should be used under the below condition:

| Item                |                         | Requirement   |
|---------------------|-------------------------|---|
| Working Conditions  | Water Pressure          | 0.2MPa ~ 0.6MPa   |
|                     | Water Temperature       | 5℃ ~ 50℃  |
| Working Environment | Environment Temperature | 5℃ ~ 50℃  |
|                     | Relative Humidity       | ≤95% ( 25℃ )  |
|                     | Electrical Facility     | AC100 ~ 240V/50 ~ 60Hz  |
| Inlet Water Quality | Water Turbidity         | Down-flow regeneration<5FTU;<br>Up-flow regeneration<2FTU                   |
|                     | Water Hardness          | First Grade Na <sup>+</sup> : 93610/93606<15mmol/L<br>17610/17606<6.5mmol/L |
|                     | Free Chlorine           | < 0.1mg/L   |
|                     | Iron <sup>2+</sup>      | < 0.3mg/L   |
|                     | CODMn                   | < 2mg/L ( O <sub>2</sub> )  |

In the above table, First Grade Na<sup>+</sup> represents First Grade Na<sup>+</sup> Exchanger.

- When the water turbidity exceeds the conditions, a filter should be installed on the inlet of control valve.
- When the water hardness exceeds the conditions, the outlet water hardness will hardly reach the requirement of boiler feed water (0.03 mmol/L). It is suggested to adopt second grade softener.

### 1.4.Product Structure and Technical Parameters

#### A. Product Dimension

17610:

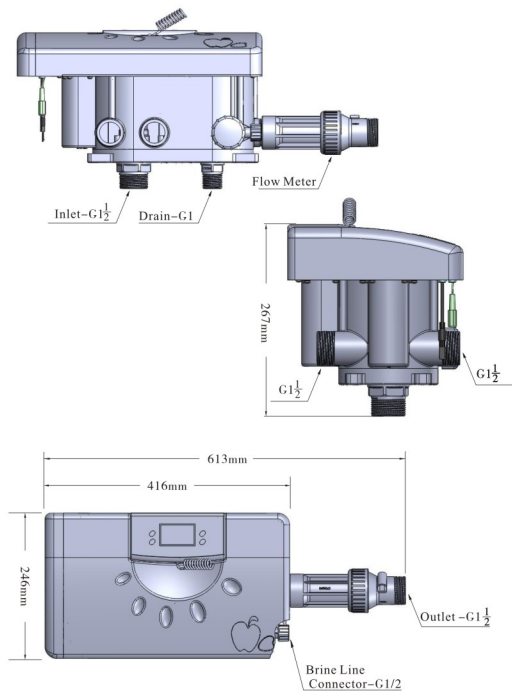

93610:

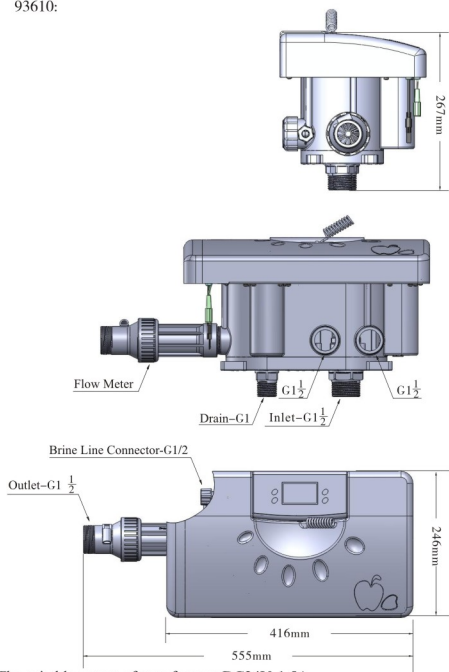

The suitable output of transformer: DC24V, 1.5A

| Model | Connect Size |       |                      |                         | Flow Rate m <sup>3</sup> /h<br>@0.3MPa | Regeneration Mode | Remark       |
|-------|--------------|-------|----------------------|-------------------------|--|-------------------|--------------|
|       | Inlet/Outlet | Drain | Brine Line Connector | Top and Bottom Strainer |  |                   |              |
| 17610 | 1.5" M       | 1" M  | 1/2" M               | 1.5" M                  | 10                                     | Meter Type        | Fixed Bed    |
| 93610 | 1.5" M       | 1" M  | 1/2" M               | 1.5" M                  | 10                                     |                   | Floating Bed |

17606:

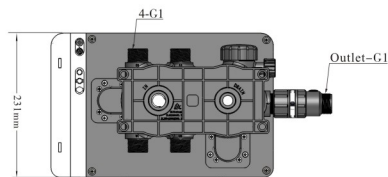
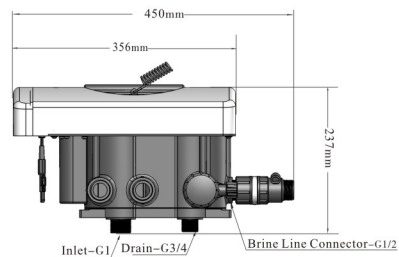

93606:

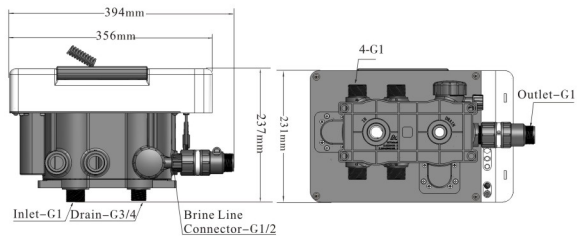

The suitable output of transformer: DC12V, 1.5A

| Model | Connect Size |        |                      |                         | Flow Rate m <sup>3</sup> /h @0.3MPa | Regeneration Mode | Remark       |
|-------|--------------|--------|----------------------|-------------------------|-------------------------------------|-------------------|--------------|
|       | Inlet/Outlet | Drain  | Brine Line Connector | Top and Bottom Strainer |                                     |                   |              |
| 17606 | 1" M         | 3/4" M | 1/2" M               | 1" M                    | 6                                   | Meter Type        | Fixed Bed    |
| 93606 | 1" M         | 3/4" M | 1/2" M               | 1" M                    | 6                                   |                   | Floating Bed |

## 1.5.Installation

### A.Installation notice

Before installation, read all those instructions completely. Then obtain all materials and tools needed for installation.

The installation of product, pipes and circuits, should be accomplished by professional to ensure the product can operate normally.

Perform installation according to the relative pipeline regulations and the specification of Inlet, Outlet, Drain, Brine Line Connector.

Be sure the correct installation direction and pipeline for 17610/17606 and 93610/93606.

### B.Device location

- ①The softener should be located close to the drain.
- ②Ensure the unit is installed in enough space for operating and maintenance.
- ③Brine tank should be close to the softener.
- ④The unit should be kept away from the heater, and not be exposed outdoor. Sunshine or rain will damage the system.
- ⑤Avoid installing the system in the Acid/Alkaline, Magnetic or strong vibration circumstance, because above factors will cause the system disorder.
- ⑥Do not install the softener, drain pipeline in circumstance which temperature may drop below 5°C, or above 50°C.
- ⑦One place is recommended to install the system which cause the minimum loss in case of water leaking.

### ①Support installation

Take out all the fittings and screws and assemble them according to Figure 1-1.

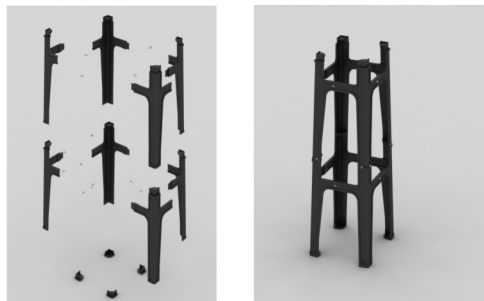

Figure 1-1

### ②Install control valve

- a. Fix the control valve, fittings and support with screws(Figure 1-2a)
- b. Connect control valve with the top and bottom strainers of tank by using UPVC or PPR pipes, and install two ball valves on bottom strainer.

### ③.Pipeline installation

- a. Install flow meter and the brine line (Figure 1-2b)
- b. Put the sealing ring into the nut of flow meter, screw onto the outlet, then insert the sensor into flow meter. Please make sure the impeller works well before the installation.
- c. Insert tube bushing into the end of brine tube and connect onto the brine line connector with nut. Connect the other end of brine tube into the brine tank. (The liquid level controller and air-blocker should be installed in the brine tank.)

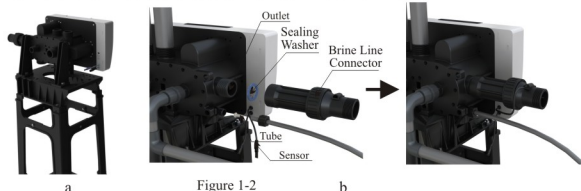

Figure 1-2

#### ④ Top and bottom distributor installation

The distributors should be corresponding to U1 tank and U2 tank.

#### ⑤ Pipeline connection

a. Please install a pressure gauge onto the inlet pipeline; then install ball valves A, B and C on inlet, outlet and the pipe between inlet and outlet for easy maintenance.

b. Inlet pipeline should be in parallel with outlet pipeline. Support inlet and outlet pipeline with fixed holder. (Figure 1-3)

Notice:

- If making a soldered copper installation, do all sweat soldering before connecting pipes to the valve. Torch heat will damage plastic parts.
- When turning threaded pipe fittings onto plastic fitting, use care not to cross thread or broken valve.
- Control valve should be higher than drain outlet, and be better not far from the drain hose.
- Be sure not connect drain with sewer, and leave a certain space between them, avoid wastewater be absorbing to the water treatment equipment.
- The brine tube and drain pipeline should not be bended or plugged.
- The height of resin volume in floating bed system should not lower than 1200mm. Usually, 200mm water subfill should be left for avoiding disordering resin and outputting unqualified water.
- There is no backwash for floating bed, the resin need to be cleaned after using for a certain time. The inlet turbidity shall less than 2 FTU.

The Installation of 17610/17606



The installation of 93610/93606



Figure 1-3

Notice:

- Avoid floccules substance together with resin to fill in the mineral tank.
- Piping installation should be straight, and shall not make control valves or the fittings by torsion

## 2. Basic Setting & Usage

### 2.1 The Function of PC Board

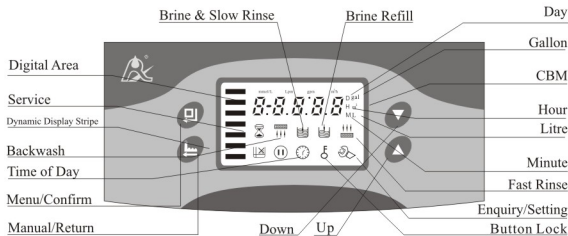



- A. Time of day indicator  
 Light on, display the time of day.
- B. Button lock indicator  
 ● Light on, indicate the buttons are locked. At this moment, press button will not work. (No operation within one minute, will light on and lock the buttons.)  
 ● Solution: Press and hold both and for 5 seconds until the light off
- C. Program mode indicator  
 ● Light on, enter program display mode. Use or to view all values.  
 ● Flash and enter program set mode. Press or to adjust values.
- D. Manu/Confirm button  
 ● Press , light on, enter program display mode and use or to view all values.  
 ● In program display mode, press , flash, enter program set mode, press or and adjust values.  
 ● Press after all program are set, and then the voice “Di” means all setting are successful and return program display mode.
- E. Manual/Return button   
 ● Press in any status, it can proceed to next step. (Example: when the water is unqualified, press in Service status, it turns into regeneration cycles instantly; press in regeneration or rinse status when you want to step into next position. )  
 ● Press in program display mode, it will return to Service status; Press in program set mode, and it will return to program display mode.  
 ● Press while adjusting the value, it will return to program display mode directly without saving value.
- F. Down and Up   
 ● In program display mode, press or to view all values.  
 ● In program set mode, press or to adjust values.  
 ● Press and hold both and for 5 seconds to lift the Button Lock status.

## 2.2. Basic Setting & Usage

### A. Parameter Specification

| Function    | Indicator | Factory Default | Parameter Set Range | Instruction                           |
|-------------|-----------|-----------------|---------------------|---------------------------------------|
| Time of Day | 12:12     | Random          | 00:00—23:59         | Set the time of day when use;  flash. |

|                                    |       |         |                       |  |
|------------------------------------|-------|---------|-----------------------|--|
| Control Mode                       | A-01  | A-01    | A-01                  | Meter immediate type: Regenerate immediately when the available volume of treated water drops to zero (0).   |
|                                    |       |         | A-02                  | Meter intelligent type: Regenerate immediately when the calculated available volume of treated water drops to zero (0).  |
| Interval Backwash Times            | F-00  | F-00    | 0 ~ 20                | Interval backwash times. For example, F-01 indicates service 2 times, backwash 1 time.   |
| Water Treatment Capacity           | 80.00 | 80.00   | 0 ~ 999.99            | Water treatment capacity in one circle (m <sup>3</sup> )   |
| Unit Mode                          | HU-01 | HU-01   | 01、02、03              | 01-m <sup>3</sup> ; 02-Gal; 03-L   |
| Resin Volume                       | 50L   | 50L     | 20 ~ 500              | Resin volume in brine tank.(L)   |
| Feed Water Hardness                | Yd1.2 | 1.2     | 0.1 ~ 30<br>0.1 ~ 9.9 | Feed Water Hardness (mmol/L); 0.1-30 for 93610/93606; and 0.1-9.9 for 17610/17606.   |
| Exchange Factor                    | AL.65 | 0.65    | 0.30 ~ 0.99           | /  |
| Fast Rinse Time                    |       | 10 min. | 0 ~ 99 : 59           | Fast rinse time (Min.)   |
| Settling Bed Time                  |       | 10 min. | 0 ~ 99 : 59           | Settling bed time (00:00); Only for 93610/93606.   |
| Backwash Time                      |       | 10 min. | 0 ~ 99 : 59           | Backwash time(Min.) Only for 17610/17606.  |
| Brine & Slow Rinse Time            |       | 70 min. | 0 ~ 99 : 59           | Brine & Slow Rinse time (Min.)   |
| Brine Refill Time                  |       | 5 min.  | 0 ~ 99 : 59           | Brine Refill time (Min.)   |
| Maximum Interval Regeneration Days | H-30  | 30      | 0 ~ 40                | Regenerate on the day even through the available volume of treated water do not drop to zero (0)   |
| Output Control Mode                | B-01  | 01      | 01 or 02              | Mode 01: Signal turn on start of regeneration and shut off end of regeneration. (Connection refer to the Figure 1)<br>Mode 02: Signal available only intervals of regeneration cycles and in service. (Connection refer to the Figure 2) |

## B. Process Display



Figure A



Figure B



Figure C



Figure D



Figure E



Figure F



Figure G



Figure H



Figure J



Figure I



Figure L



Figure M



Figure N



Figure O



Figure P



Figure Q



Figure R

### Illustration:

- Tank U1 is in service, tank U2 is standby: the screen cycle plays Figure A/B/C/D, each for 5 seconds.
- Tank U1 is in service, tank U2 is in Fast Rinse status: the screen cycle plays Figure E/F/G/H/J, each for 5 seconds.
- When switch from tank U1 to U2, the screen displays Figure I; switch from tank U2 to U1, the screen displays Figure Q.
- Tank U2 is in service, tank U1 is in Settling Bed status: the screen cycle plays Figure R/F/M/H/J, each for 5 seconds.
- Tank U2 is in service, tank U1 is in Backwash status: the screen cycle plays Figure L/F/M/H/J, each for 5 seconds.
- Tank U2 is in service, tank U1 is in Brine & Slow Rinse status: the screen cycle plays Figure N/F/M/H/J, each for 5 seconds.
- Tank U2 is in service, tank U1 is in Brine Refill status: the screen cycle plays Figure O/F/M/H/J, each for 5 seconds.
- Tank U2 is in service, tank U1 is standby: the screen cycle plays Figure P/B/C/D, each for 5 seconds.
- The display screen will only show “-00-” or “F-00”, when the electrical motor is turning













- The time of day figure  flashes continuously, such as 12:12 flashes, indicates long outage of power. It reminds to reset the time of day.

- The display will show the error code, such as “-E11-” when the system is in error.

### C. Usage

After being accomplished installation, parameter setting and trail running by professional, the valve could be put into use. In order to ensure the quality of outlet water can reach the requirement, the user should complete the below woks:

- ① Ensure that there is solid salt all the time in the brine tank in the course of using when this valve is used for softening. The brine tank should be added the clean water softening salts only, at least 99.5% pure, forbidding use the small salt and iodized salt.
- ② Test the outlet water and raw water hardness regularly. When the outlet water hardness is unqualified, please press the  under unlock status and the valve will temporary regenerate again. (It will not affect the original set operation cycle.)
- ③ When the feed water hardness change a lot, you can adjust the water treatment capacity as follow:

Press and hold  both  and  for 5 seconds to lift the lock status. Press , and the  light on, then press , the digital area show the control mode. If it shows A-01, press  again, and the digital area will show the given water treatment capacity; press , and digital flash. It turns into water treatment capacity setting mode. Press  or  continuously, reset the capacity value. Press  and hear a sound “Di”, then finish the adjustment. Press  exit and turn back the service status.

The estimation of water treatment capacity, you can refer to the professional application specification. When select A-02 intelligent control mode, the control will automatically calculate the water treatment capacity by setting resin volume, feed water hardness and regeneration factor.

The regeneration parameters have been set when control valve left factory. Generally, it does not need to reset. If you want enquiry and modify the setting, you can refer to the professional application specification.

### 3.Applications

#### 3.1.Softener Flow Chart

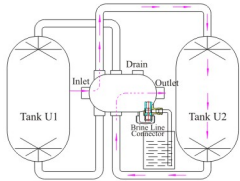

Tank U2 in Service and Tank U1 in Standby

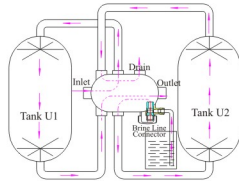

Tank U2 in Service and Tank U1 in Brine&Slow Rinse (Down-flow Regeneration)

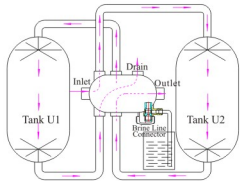

Tank U2 in Service and Tank U1 in Fast Rinse

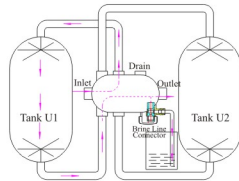

Tank U1 in Service and Tank U2 in Brine Refill

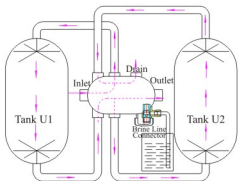

Tank U1 in Service and Tank U2 in Backwash

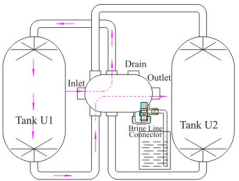

Tank U1 in Service and Tank U2 in Standby

One in service and one standby fixed bed system 17610/17606

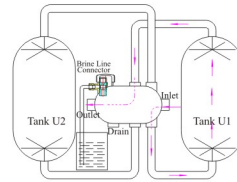

Tank U1 in Service and Tank U2 in Standby

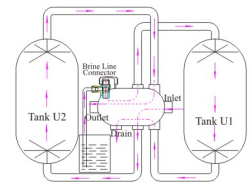

Tank U2 in Service and Tank U1 in Brine & Slow Rinse

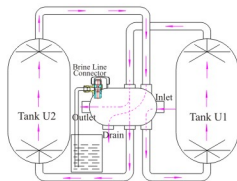

Tank U1 in Service and Tank U2 in Fast Rinse

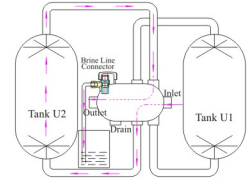

Tank U2 in Service and Tank U1 in Brine Refill

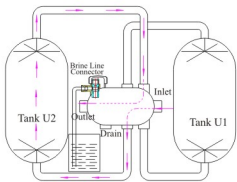

Tank U2 in Service and Tank U1 in Settling Bed

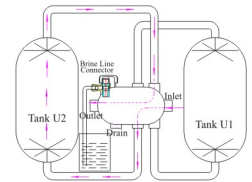

Tank U2 in Service and Tank U1 in Standby

Control valve for floating bed system 93610/93606

### 3.2.The Function and Connection of PC Board

Open the front cover of control valve, you will see the main control board and connection port as Figure 3-1.

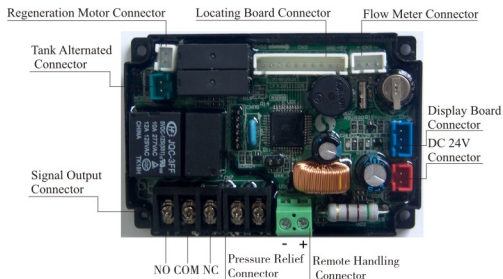

Figure 3-1.

The main functions on main control board:

| Function                     | Application  | Explanation  |
|------------------------------|--|--|
| Signal output connector b-01 | Outlet solenoid valve                                    | To strictly require no hard water flow from outlet or controlling the liquid level in water tank.                                      |
|                              | Inlet pump   | Increase pressure for regeneration or washing. Use the liquid level controller to control inlet pump to ensure there is water in tank. |
| Signal output connector b-02 | Inlet solenoid valve or inlet pump                       | When inlet pressure is high, it needs to close water inlet when valve is rotating to protect motor.                                    |
| Pressure relief connector    | Control inlet pump                                       | Turn off the inlet pump during settling bed status, and turn on in other status. Only for 93610/93606.                                 |
| Remote handling connector    | Receipt signal to make the control rotate to next circle | It is used for on-line inspection system, PC connection, and realize automatically or remote controlling valve.                        |

### A. Signal output connector

#### 1) Control Solenoid Valve (Set b-01)

①Solenoid valve on outlet controls water level in brine tank.

Instruction: If system strictly require no hard water flow from outlet in regeneration cycle ( Mainly for no hard water flow out when valve is switching or valve in backwash or brine drawing positions), a solenoid valve could be installed on outlet, the wiring refer to Figure 3-2.

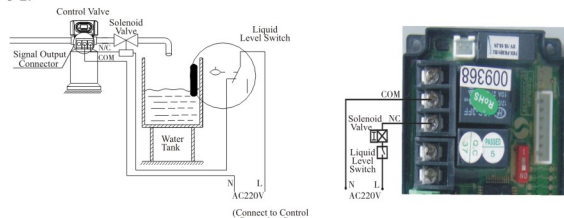

Figure3-2 Wiring of Solenoid Valve on Outlet

Function:

When valve in service status, if the water tank is short of water, solenoid valve is open to supply soft water; otherwise, the solenoid valve is closed to ensure no soft water is supplied.

When the valve in backwash status, there is no signal output. So the solenoid valve is closed and no water flows into the water tank.

#### ②Solenoid Valve on Inlet (Set b-02)

Instruction: When inlet pressure exceeds 0.6MPa, install a solenoid valve on inlet. Set the control mode to b-02. Pressure relieved when valve switching, the wiring refer to Figure 3-3. As Figure 3-4 shows, it also can use the pressure relief port to release pressure.

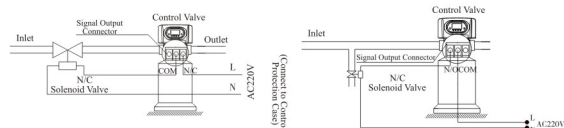

Figure 3-3 Wiring of Solenoid Valve on Inlet

Figure 3-4 Wiring of Pressure Relief Connector



### 3.3 System Configuration and Flow Rate Curve

#### A. Product Configuration

The configuration of control valve with tank, resin volume, brine tank and injector.

17610:

| Tank Size (mm) | Resin Volume (L) | Flow Rate (t/h) | Brine Tank Size (mm) | The Minimum Salt Consumption for Regeneration (Kg) | Injector Model |
|----------------|------------------|-----------------|----------------------|--|----------------|
| φ 500 × 1800   | 200              | 5.0             | φ 740 × 1275         | 30.00  | 2#             |
| φ 600 × 1800   | 300              | 7.0             | φ 740 × 1275         | 45.00  | 3#             |
| φ 750 × 1800   | 450              | 11.0            | φ 840 × 1335         | 67.50  | 3#             |

93610:

| Tank Size (mm) | Resin Volume (L)    | Flow Rate (t/h) | Brine Tank Size (mm) | The Minimum Salt Consumption for Regeneration (Kg) | Injector Model |
|----------------|---------------------|-----------------|----------------------|--|----------------|
| φ 500 × 2000   | 90% Volume of Resin | 9               | φ 840 × 1335         | 45.00  | 2#             |
| φ 600 × 2200   |                     | 12              | φ 840 × 1335         | 67.5   | 3#             |

17606:

| Tank Size (mm) | Resin Volume (L) | Flow Rate (t/h) | Brine Tank Size (mm) | The Minimum Salt Consumption for Regeneration (Kg) | Injector Model |
|----------------|------------------|-----------------|----------------------|--|----------------|
| φ 500 × 1800   | 200              | 4.0             | φ 740 × 1275         | 30.00  | 2#             |
| φ 600 × 1800   | 300              | 6.0             | φ 740 × 1275         | 45.00  | 3#             |

93606:

| Tank Size (mm) | Resin Volume (L)    | Flow Rate (t/h) | Brine Tank Size (mm) | The Minimum Salt Consumption for Regeneration (Kg) | Injector Model |
|----------------|---------------------|-----------------|----------------------|--|----------------|
| φ 450 × 1665   | 90% Volume of Resin | 6.0             | φ 840 × 1335         | 45.00  | 3#             |
| φ 600 × 2200   |                     | 8.0             | φ 840 × 1335         | 67.5   | 3#             |

Note: The flow rate here is the theoretical calculation based on linear velocity 25 m/h (17610/17606) / 45 m/h (93610/93606); the minimum salt consumption for regeneration calculation is based on salt consumption 150g / L (Resin).

#### B. Flow Rate Characteristic

##### 1) Pressure-flow rate curve

17610

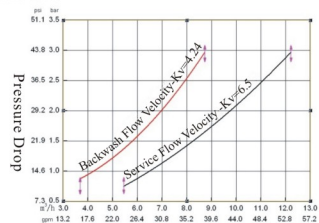

93610

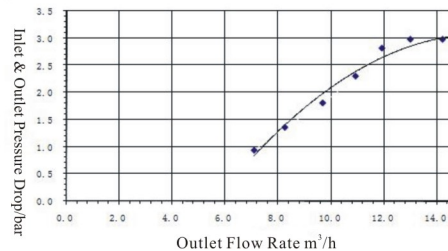

17606

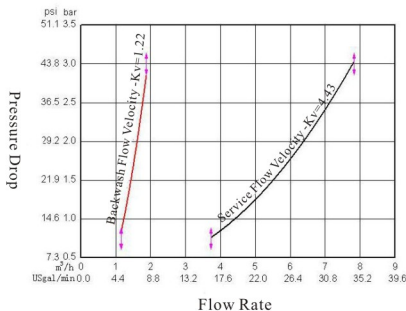

93606

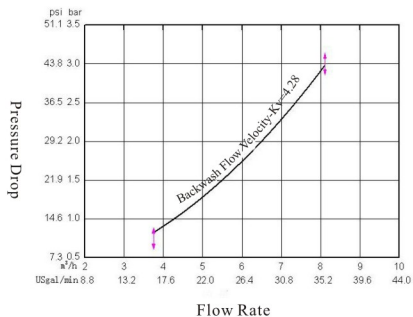

-26-

## 2) Injector parameter table

| Pressure of inlet | Draw Rate (L/Min.) |           |         |           |           |  |
|-------------------|--------------------|-----------|---------|-----------|-----------|--|
|                   | 93610/17610        |           | 17606   |           | 93606     |  |
| Mpa               | 2# Pink            | 3# Yellow | 2# Pink | 3# Yellow | 3# Yellow |  |
| 0.15              | 13.86              | 16.08     | 8.42    | 9.67      | 8.19      |  |
| 0.20              | 16.60              | 19.32     | 9.64    | 11.11     | 9.15      |  |
| 0.25              | 18.17              | 21.30     | 10.74   | 12.35     | 9.96      |  |
| 0.30              | 20.00              | 23.40     | 11.89   | 13.57     | 14.88     |  |
| 0.35              | 21.64              | 25.19     | 12.89   | 14.93     | 16.01     |  |
| 0.40              | 23.33              | 26.98     | 13.54   | 15.41     | 16.47     |  |

## 3) Configuration for standard injector and drain line flow control

| Tank Dia. (mm) | Injector Model | Injector Color | Draw Rate | Slow Rinse Rate | Brine Refill Rate | Backwash / Fast Rinse |
|----------------|----------------|----------------|-----------|-----------------|-------------------|-----------------------|
|                |                |                | L/min     | L/min           | L/min             | L/min                 |
| 500            | 2#             | Pink           | 16.0      | 10.56           | 23                | 46.3                  |
| 600            | 3#             | Yellow         | 23.4      | 15.75           | 32.9              | 71                    |
| 750            | 3#             | Yellow         | 23.4      | 15.75           | 32.9              | 71                    |

Remark: Above data for the product configuration and relevant characteristics are only for reference. When put in practice, please subject to the different requirements of raw water hardness and application.

-27-

### 3.4. Parameter Settlement

#### ① Service time T1

Water treatment capacity:

$$Q = V_R \times K \div Y_D \quad (\text{m}^3)$$

$V_R$  — Resin volume (m<sup>3</sup>)  
 $K$  — Exchange factor (mmol/L) 400~1000.  
 Down-flow regeneration, take 400~750.  
 Up-flow regeneration, take 450~1000.  
 If the inlet water hardness is higher, the factor is smaller.  
 $Y_D$  — Hardness of inlet water (mmol/L)

By hours:  $T1 = Q \div Q_h$  (Hour)

$Q_h$  — Water treatment capacity per hour (m<sup>3</sup>/h)  
 $Q$  — Water treatment capacity (m<sup>3</sup>)

By days:  $T1 = Q \div Q_d$  (Day)

$Q_d$  — Water treatment capacity per day (m<sup>3</sup>/d)  
 $Q$  — Water treatment capacity (m<sup>3</sup>)

#### ② Backwash time T2 (Only for 17610/17606)

It is subject to the turbidity of the inlet water. Generally, it is suggested to be set 10-15 minutes. The higher the turbidity is, the longer backwash time can be set. If the turbidity is more than 5 FTU, it should be better to install a filter in front of the exchanger.

#### ③ Settling bed time T3 (Only for 93610/93606)

The time of the resin flowing down to the bottom of the tank. It is suggested to be set 8-12 minutes,

#### ④ Brine drawing and slow rinse time T4

$$T4 = (40-50) \times H_R \quad (\text{Min.})$$

Generally,  $T4 = 45 H_R$  (Min.) (It is better within 45~65 Min.)

In this formula,  $H_R$  — The height of resin in exchange tank (m).

#### ⑤ Brine refill time T5

Down-flow regeneration:  $T5 = 0.45 \times V_R \div \text{Brine refill speed}$  (Min.)

Up-flow regeneration:  $T5 = 0.34 \times V_R \div \text{Brine refill speed}$  (Min.)

In this formula,  $V_R$  — Resin volume (m<sup>3</sup>)

The brine refill speed is related to inlet water pressure. It is suggested to lengthen 1-2 minutes of calculated brine refilling time to make sure there is enough water in tank. (The condition is that there is a level controller installed in the brine tank.)

#### ⑥ Fast rinse time T6

$$T6 = 12 \times H_R \quad (\text{Min.})$$

Generally, the water for fast rinse is 3~6 times of resin volume. It is suggested to be set 10~16 minutes, but subject to the outlet water reaching the requirement.

#### ⑦ Exchange factor

$$\text{Exchange factor} = E / (k \times 1000)$$

In this formula,  $E$  — Resin working exchange capability (mol/m<sup>3</sup>). It is related to the quality of resin. Down-flow regeneration, take 800~900. Up-flow regeneration, take 900~1200.

$K$  — Security factor, always take 1.2~2. It is related to the hardness of inlet water: the higher the hardness is, the bigger the  $K$  is.

#### ⑧ Set up interval backwash times (Only for 17610/17606)

When the turbidity of raw water is higher, the interval backwash time should be set F-00. That is, backwash in each regeneration; when the turbidity is lower, the interval backwash time could be set F-01 (Or other number value.), it is to say that backwash in every two regenerations. Thus, Fast rinse → Service → Brine & Slow rinse → Brine refill → Fast rinse → Service → Backwash → Brine & Slow rinse → Brine refill → Fast rinse.

The calculation of parameters for each step is only for reference, the actual proper time will be determined after adjusting by water exchanger supplier. This calculation procedure of softener is only for industrial application; it is not suitable for small softener in residential application.

### 3.5. Parameter Enquiry and Setting

#### 3.5.1. Parameter enquiry

When  $\text{⏻}$  light on, press and hold both  $\text{⬆}$  and  $\text{⬇}$  for 5 seconds to lift the button lock status; then press  $\text{⏻}$  and  $\text{⏻}$  light on, enter to program display mode; press  $\text{⬆}$  or  $\text{⬇}$  to view each value according to below process. (Press  $\text{⏻}$  exit and turn back to service status.)

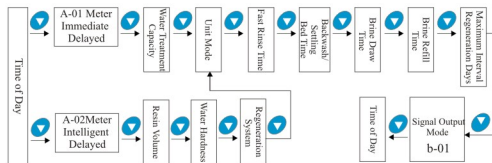































### 3.5.2. Parameter setting

In program display mode, press and enter into program set mode. Press or to adjust the value.





### 3.5.3. The steps of parameter setting

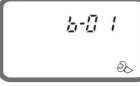







| Item                     | Process Step  | Symbol |
|--------------------------|---|--------|
| Time of Day              | <p>When time of day "12:12" continuously flash, it reminds to reset;</p> <p>1. Press  to enter into program display mode; both  and  symbol light on, ":" flash;</p> <p>2. Press , both  and hour value flash, through  or  to adjust the value;</p> <p>3. Press  again, both  and minute value flash, through  or  to adjust the minute value;</p> <p>4. Press  to finish the adjustment, press  to turn back.</p> |        |
| Control Mode             | <p>1. In control mode display status, press  and enter into program set mode,  and 01 value flash;</p> <p>2. Press  or , set the value to be A-01 or A-02 control mode;</p> <p>3. Press  to finish the adjustment, press  to turn back.</p>   |        |
| Interval backwash times  | <p>1. In interval backwash times display status, it shows F-00. Press  and enter into program set mode.  and 00 flash;</p> <p>2. Press  or  to adjust the value of times;</p> <p>3. Press  to finish adjustment, press  to turn back.</p>   |        |
| Water Treatment Capacity | <p>1. In water treatment capacity display status, it shows  and 10.00. Press  and enter into program set mode.  and 10.00 flash;</p> <p>2. Press  or  to adjust the water treatment capacity value;</p> <p>3. Press  to finish adjustment, press  to turn back.</p>   |        |

|                     |   |  |
|---------------------|---|--|
| Resin Volume        | <p>1. In resin volume display status, it shows 50 L; press  and enter into program set mode.  And 50 flash.</p> <p>2. Press  or  to adjust the resin volume in the tank.</p> <p>3. Press  to finish the adjustment, press  to turn back.</p>          |  |
| Feed Water Hardness | <p>1. In feed water hardness display status, it shows yd 1.2. Press  and enter into program set mode.  and 1.2 flash;</p> <p>2. Press  or  to adjust the hardness value (mmol/L);</p> <p>3. Press  to finish the adjustment, press  to turn back.</p> |  |
| Exchange Factor     | <p>1. In exchange factor display status, it shows AL.55. Press  and enter into program set mode.  and 55 flash.</p> <p>2. Press  or  to adjust the exchanger factor value;</p> <p>3. Press  to finish the adjustment, press  to turn back.</p>        |  |
| Service Time        | <p>1. In service time display status, it shows  and 1-10:00; press  and enter into set mode.  and 10 flash.</p> <p>2. Press  or  to adjust the service time.</p> <p>3. Press  to finish the adjustment, press  to turn back.</p>                      |  |
| Backwash Time       | <p>1. In backwash time display status, it shows  and 2-10:00; press  and enter into set mode.  and 10 flash.</p> <p>2. Press  or  to adjust the backwash time.</p> <p>3. Press  to finish the adjustment, press  to turn back.</p>                    |  |

|                                    |  |   |
|------------------------------------|--|---|
| Brine & Slow Rinse Time            | <p>1. In brine &amp; slow rinse time display status, it shows  and 3-60:00; press  and enter into program set mode.  and 60:00 flash;</p> <p>2. Press  or  to adjust the brine &amp; slow rinse time;</p> <p>3. Press to  finish the adjustment, press  to turn back.</p> |  |
| Brine Refill Time                  | <p>1. In brine refill time display status, it shows  and 4-05:00; press  and enter into program set mode.  and 05:00 flash;</p> <p>2. Press  or  to adjust the brine refill time;</p> <p>3. Press  to finish the adjustment, press  to turn back.</p>                     |  |
| Maximum Interval Regeneration Days | <p>1. In maximum interval regeneration days display status, it shows H-30; press  and enter into program set mode.  and 30 flash;</p> <p>2. Press  or  to adjust the Interval regeneration days;</p> <p>3. Press  to finish the adjustment, press  to turn back.</p>   |  |
| Signal Output Mode                 | <p>1. In signal output mode display status, it shows b-01; press  and enter into program set mode.  and 01 flash;</p> <p>2. Press  or  to adjust the signal output mode to b-02;</p> <p>3. Press  to finish the adjustment, press  to turn back.</p>   |  |





For example, the fast rinse time of a softener is 12 minutes. After regenerating, the chloridion in the outlet water is always higher than normal, indicating that there is not enough time for fast rinse. If you want the time to set to 15 minutes, the modification steps as follows:

- ① Press and hold both  and  to lift the button lock statuses (  light off) ;
- ② Press  , and  light on:

- ③ Press  or  continuously until  light on. Then the digital area shows: 1-12:00M;
- ④ Press  ,  and 12:00 flash;
- ⑤ Press  continuously until 12 changed to 15;
- ⑥ Press  , there is a sound “Di” and the figure stop flashing; the program back to enquiry status
- ⑦ If you want to adjust other parameters, you can repeat the steps from ② to ⑤; If you don't, press  and quit from the enquiry stat, the display will show the current service status.

### 3.6.Trial Running

After installing the multi-functional flow control valve on the resin tank with the connected pipes, as well as setting up the relevant parameter, please conduct the trail running as follows:

- A.Close the ball valve B & C, and open the bypass valve A. After cleaning the foreign materials in the pipe, close the bypass valve A. (As Figure 5 shows.)
- B.Set tank U1 at service status, U2 at standby status.
- C.Turn the inlet ball valve B to quarter open, fill tank U1. Then open outlet valve C. After no air in pipeline, close valve C. Make sure the system without leakage.
- D.Turn the ball valve B to full open.
- E.Press  to switch tank U2 to Service status and tank U1 to backwash status, making the water flow out from the drain for 3-4 minutes.
- F.Fill the brine tank with the planned amount of water and adjust the air check valve. Then add solid salt to the tank and dissolve the salt as much as possible.
- G.Press  to switch control valve to Brine & Slow Rinse status, stay in this status for few minutes after finishing the brine draw..
- H.Press  to switch control valve to Standby status.
- I.Press  to switch control valve to Fast Rinse status for few minutes.
- J.After the treated water reaches the requirement, press  to switch tank U1 to Service status and tank U2 to Backwash status, making the water flow out from the drain for 3-4 minutes.
- K.Repeat steps from 6 to 9, turn tank U1 to Service status and tank U2 to Standby status, then the system is ready to use.

Note:

- If water inflow too fast, the media in tank will be damaged. When water inflow

slowly, there is a sound of air emptying from drain pipeline.

- After changing resin, please empty air in the resin according to the above Step C.
- In the process of trial running, please check the water situation in all position, ensuring there are no resin leakage.
- The time for Settling Bed, Brine Drawing, Slow Rinse, Fast Rinse, and Brine Refill status can be set and executed according to the calculation in the formula or suggestions from the control valve suppliers.

### 3.7. Trouble-Shooting

#### A. Control Valve Fault

| Problem                           | Cause  | Correction  |
|-----------------------------------|--|---|
| 1. Softener fails to regenerate.  | A. Electrical service to unit has been interrupted.<br>B. Regeneration cycles set incorrect.<br>C. Controller is defective<br>D. Motor fails to work.  | A. Assure permanent electrical service (Check fuse, plug, pull chain or switch).<br>B. Reset regeneration cycles.<br>C. Replace controller.<br>D. Replace motor.  |
| 2. Softener supply hard water.    | A. Bypass valve is open or leaking.<br>B. No salt in brine tank.<br>C. Injector is plugged.<br>D. Insufficient water flowing into brine tank.<br>E. Leak at O-ring on riser pipe.<br>F. Internal valve leak. | A. Close or repair bypass valve.<br>B. Add salt to brine tank and maintain salt level above water level.<br>C. Change or clean injector.<br>D. Check brine tank refill time.<br>E. Make sure riser pipe is not cracked. Check o-ring and tube pilot.<br>F. Change valve body. |
| 3. Softener fails to draw brine.  | A. Line pressure is too low.<br>B. Brine line is plugged.<br>C. Brine line is leaking.<br>D. Injector is plugged.<br>E. Internal control leak.   | A. Increase line pressure.<br>B. Clean brine line.<br>C. Replace brine line.<br>D. Clean or replace new parts.<br>E. Replace valve body.  |
| 4. Excessive water in brine tank. | A. Overlong refilling time.<br>B. Excessive water after brine.   | A. Reset correct refilling time.<br>B. Clean brine line and injector.   |

|  |   |  |
|--|---|--|
| 5. Pressure lost                       | A. Iron in the water supply pipe.<br>B. Iron mass in the softener.  | A. Clean the water supply pipe.<br>B. Clean valve and add resin cleaning chemical, increase frequency of regeneration.                           |
| 6. Loss of mineral through drain line. | A. Air in water system.   | A. Assure that well system has proper air eliminator control.  |
| 7. Control cycle continuously.         | A. Locating signal wiring breakdown.<br>B. Controller is faulty.<br>C. Foreign material stuck the driving gear. | A. Check and connect locating signal wiring.<br>B. Replace controller.<br>C. Take out foreign material.  |
| 8. Drain flows continuously.           | A. Internal valve leak.<br>B. When electricity fails to supply, valve stops backwash or rapid rinse position.   | A. Check and repair valve body or replace it.<br>B. Adjust valve to service status or turn off bypass valve and restart when electricity supply. |

#### B. Controller Fault

| Problem                                   | Cause  | Correction  |
|---|--|---|
| 1. All indicators display on front panel. | A. Wiring of front panel with controller fails to work.<br>B. Control board is faulty.<br>C. Transformer damaged.<br>D. Electrical service not stable.   | A. Check and replace the wiring.<br>B. Replace control board.<br>C. Check and replace transformer.<br>D. Check and adjust electrical service.                                   |
| 2. No display on front panel.             | A. Wiring of front panel with controller fails to work.<br>B. Front panel damaged.<br>C. Control board damaged.<br>D. Electricity is interrupted.  | A. Check and replace wiring.<br>B. Replace front panel.<br>C. Replace control board.<br>D. Check electricity.   |
| 3. E11 Flash                              | A. Wiring of locating board with controller fails to work.<br>B. Locating board damaged.<br>C. Mechanical driven failure.<br>D. Faulty control board.<br>E. Wiring of tank switching motor with controller is fault.<br>F. Tank switching motor damaged. | A. Replace wiring.<br>B. Replace locating board.<br>C. Check and repair mechanical part.<br>D. Replace control board.<br>E. Replace wiring.<br>F. Replace tank switching motor. |

|                     |   |  |
|---------------------|---|--|
| 4. E21 Flash        | <p>A. Wiring of locating board with controller fails to work.<br/>         B. Locating board damaged.<br/>         C. Mechanical driven failure.<br/>         D. Faulty control board.<br/>         E. Wiring of regeneration motor with controller is fault.<br/>         F. Regeneration motor damaged.</p> | <p>A. Replace wiring.<br/>         B. Replace locating board.<br/>         C. Check and repair mechanical part.<br/>         D. Replace control board.<br/>         E. Replace wiring.<br/>         F. Replace regeneration motor.</p> |
| 5. E12 or E22 Flash | <p>A. Hall component on locating board damaged.<br/>         B. Wiring of locating board with controller fails to work.<br/>         C. Control board is faulty.</p>  | <p>A. Replace locating board.<br/>         B. Replace wiring.<br/>         C. Replace control board.</p>   |
| 6. E3 or E4 Flash   | <p>A. Control board is faulty.</p>  | <p>A. Replace control board.</p>   |

### 3.8.Assembly & Parts

#### 93610/17610 Valve Body Assemble

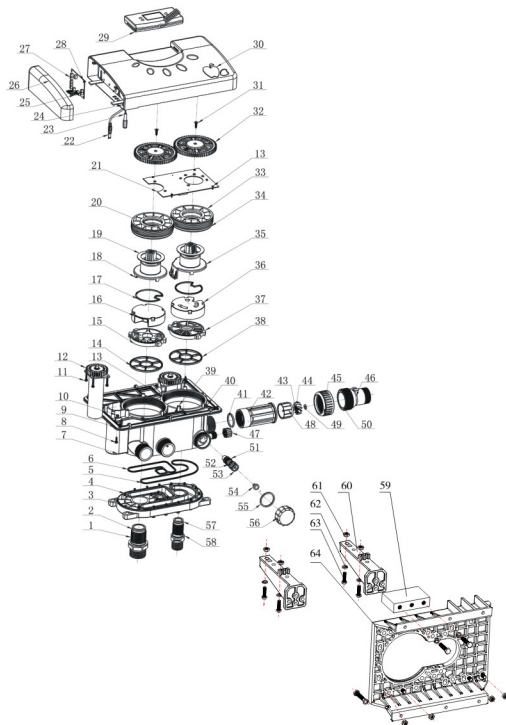

## 93610/17610 Valve Body Components and part Number

| Item no. | Description             | Part No. | Quantity |
|----------|-------------------------|----------|----------|
| 1        | Reducer                 | 8458055  | 1        |
| 2        | O-ring 35.5 × 2.65      | 8378086  | 1        |
| 3        | Valve Body              | 8022151  | 1        |
| 4        | Screw M5 × 35           | 8902017  | 17       |
| 5        | Seal Ring               | 8371027  | 1        |
| 6        | Seal Ring               | 8371028  | 1        |
| 7        | Valve Body              | 5022041  | 1        |
| 8        | Screw (3 parts) M4 × 16 | 8902006  | 4        |
| 9        | Connect Board           | 8152014  | 1        |
| 10       | Nut                     | 8940002  | 4        |
| 11       | Screw (3 parts) M4 × 32 | 83902010 | 8        |
| 12       | Motor                   | 6158038  | 1        |
| 13       | Screw ST 2.9 × 9.5      | 8909008  | 14       |
| 14       | Seal Ring               | 8370071  | 1        |
| 15       | Fixed Disk              | 8469044  | 1        |
| 16       | Moving Disk             | 8459047  | 1        |
| 17       | Moving Seal Ring        | 8370018  | 2        |
| 18       | Shaft                   | 8258005  | 1        |
| 19       | Anti-friction Washer    | 8216006  | 2        |
| 20       | O-ring 59.92 × 3.53     | 8378110  | 4        |
| 21       | Locating Board          | 380002   | 1        |
| 22       | Probe Wire              | 6386001  | 1        |
| 23       | Power Wire              | 5513001  | 1        |
| 24       | Wire Clasp              | 8126004  | 2        |
| 25       | Wire for Locating Board | 5511010  | 2        |
| 26       | Control Box             | 8300028  | 1        |
| 27       | Control Board           | 6382019  | 1        |
| 28       | Screw ST2.2 × 6.5       | 8909004  | 8        |
| 29       | Control Box Fitting     | 5356029  | 1        |

| Item No. | Description         | Part No.    | Quantity |
|----------|---------------------|-------------|----------|
| 30       | Weather Cover       | 8005029     | 1        |
| 31       | Screw ST4.8 × 19    | 8909018     | 2        |
| 32       | Gear                | 5241015     | 2        |
| 33       | Fitting Nut         | 8092005     | 2        |
| 34       | O-ring 117.6 × 3.55 | 8378113     | 2        |
| 35       | Shaft               | 8258026     | 1        |
| 36       | Moving Disk         | 8459048     | 1        |
| 37       | Fixed Disk          | 8469045     | 1        |
| 38       | Seal Ring           | 8370072     | 1        |
| 39       | Pin 2.5 × 12        | 8993004     | 2        |
| 40       | Screw ST3.9 × 19    | 8909016     | 12       |
| 41       | Seal Ring           | 8371010     | 1        |
| 42       | Connect Fitting     | 8458062     | 1        |
| 43       | Rotate Core         | 8211003     | 1        |
| 44       | Impeller            | 8436009     | 1        |
| 45       | Animated Nut        | 8947023     | 1        |
| 46       | Shell               | 5002004     | 1        |
| 47       | Nut                 | 8940016     | 1        |
| 48       | Toggle              | 8109040     | 1        |
| 49       | Bushing             | 8210002     | 1        |
| 50       | O-ring 50.39 × 3.53 | 8378107     | 1        |
| 51       | O-ring 19 × 1.8     | 8378021     | 1        |
| 52       | O-ring 20 × 1.8     | 8378024     | 1        |
| 53       | Throat, Injector    | 8467022~025 | 1        |
| 54       | Nozzle, Injector    | 8454027~030 | 1        |
| 55       | Seal Ring           | 8371006     | 1        |
| 56       | Injector            | 8315013     | 1        |
| 57       | O-ring 24 × 2.6     | 8378061     | 1        |
| 58       | Reducer             | 8458056     | 1        |

| Item No. | Description   | Part No. | Quantity |
|----------|---------------|----------|----------|
| 59       | Fixed Part    | 8109041  | 1        |
| 60       | Fixed Part    | 8109043  | 2        |
| 61       | Nut, Hex. Hd  | 8940023  | 8        |
| 62       | Spring Wahser | 8953006  | 8        |
| 63       | Hex Bolt      | 8920007  | 10       |
| 64       | Backplate     | 8109053  | 1        |

93606/17606 Valve Body Assemble

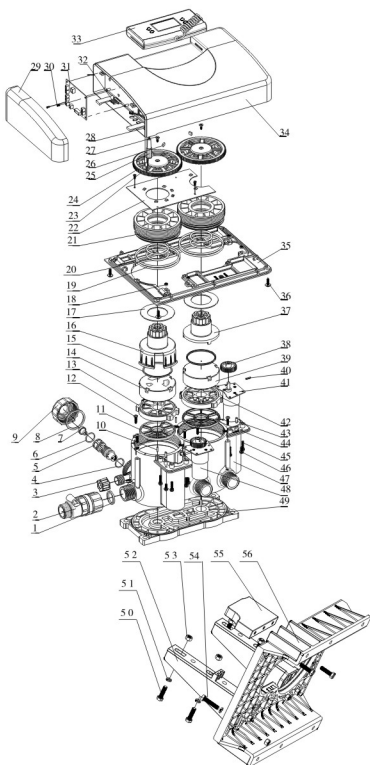

## 17606/93606 Valve Body Components and part Number

| Item No. | Description                               | Part No. | Quantity |
|----------|---|----------|----------|
| 1        | Washer $\phi 30 \times \phi 24 \times 33$ | 8371001  | 1        |
| 2        | Flow Meter                                | 5447001  | 1        |
| 3        | Nut                                       | 8940016  | 1        |
| 4        | O-ring $19 \times 1.8$                    | 8378021  | 1        |
| 5        | Throat, Injector                          | 8467024  | 1        |
| 6        | O-ring $20 \times 1.8$                    | 8378024  | 1        |
| 7        | Nozzle, Injector                          | 8454029  | 1        |
| 8        | Seal Ring                                 | 8371006  | 1        |
| 9        | Injector Cover                            | 8315013  | 1        |
| 10       | Pin $2.5 \times 12$                       | 8993004  | 2        |
| 11       | Seal Ring                                 | 8370084  | 1        |
| 12       | Screw ST3.9 $\times 13$                   | 8909003  | 12       |
| 13       | Fixed Disk                                | 8469056  | 1        |
| 14       | Moving Disk                               | 8459055  | 1        |
| 15       | Moving Seal Ring                          | 8370065  | 2        |
| 16       | Shaft                                     | 8258030  | 1        |
| 17       | Anti-friction Washer                      | 8216012  | 2        |
| 18       | Nut, Hex. Hd                              | 8940002  | 4        |
| 19       | O-ring $92.5 \times 3.55$                 | 8378199  | 4        |
| 20       | O-ring $43.7 \times 3.55$                 | 8378123  | 4        |
| 21       | Fitting Nut                               | 8092037  | 2        |
| 22       | Locating Board                            | 6380029  | 1        |
| 23       | Probe Wire                                | 6386001  | 1        |
| 24       | Gear                                      | 8241030  | 2        |
| 25       | Power Wire                                | 5513001  | 1        |
| 26       | Magnet                                    | 8610.001 | 2        |
| 27       | Screw ST3.9 $\times 19$                   | 8909012  | 2        |
| 28       | Wire Clasp                                | 8126004  | 3        |
| 29       | Control Box                               | 8300012  | 1        |

| Item No. | Description                    | Part No. | Quantity |
|----------|--------------------------------|----------|----------|
| 30       | Screw ST2.9 $\times 9.5$       | 8909008  | 10       |
| 31       | Control Board                  | 6382019  | 1        |
| 32       | Wire for Locating Board        | 5511010  | 1        |
| 33       | Control Box Fitting            | 5356029  | 1        |
| 34       | Weather Cover                  | 8005011  | 1        |
| 35       | Connect Board(93606)           | 8152021  | 1        |
|          | Connect Board(17606)           | 8152023  | 1        |
| 36       | Gasket $\phi 4 \times 12$      | 8952010  | 4        |
| 37       | Shaft                          | 8258014  | 1        |
| 38       | Gear                           | 8241012  | 2        |
| 39       | Moving Disk                    | 8459054  | 1        |
| 40       | Pin $\phi 2.5 \times 12$       | 8993003  | 2        |
| 41       | Motor(93606)                   | 6158013  | 1        |
|          | Motor(17606)                   | 6158012  | 1        |
| 42       | Fixed Disk                     | 8469055  | 1        |
| 43       | Pin $\phi 4 \times 12$         | 8993006  | 4        |
| 44       | Seal Ring                      | 8370083  | 1        |
| 45       | Screw (3 parts) M4 $\times 20$ | 8902007  | 8        |
| 46       | Screw (3 parts) M4 $\times 12$ | 8902005  | 4        |
| 47       | Valve Body                     | 8022165  | 1        |
| 48       | Motor(93606)                   | 6158012  | 1        |
|          | Motor(17606)                   | 6158013  | 1        |
| 49       | Valve Body                     | 8022166  | 1        |
| 50       | Hex Bolt M8 $\times 30$        | 8920012  | 4        |
| 51       | Spring Washer $\phi 8$         | 8953005  | 10       |
| 52       | Fixed Part                     | 8109043  | 2        |
| 53       | Nut, Hex. Hd M8                | 8940021  | 8        |
| 54       | Hex Bolt M8 $\times 40$        | 8920008  | 4        |
| 55       | Fixed Part                     | 8109049  | 1        |
| 56       | Backplate                      | 8109053  | 1        |

## 4. Warranty Card

Dear client:

This warranty card is the guarantee proof of RUNXIN brand multi-functional flow control valve. It is kept by client self. You could get the after-sales services from the supplier which is appointed by RUNXIN manufacturer. Please keep it properly. It couldn't be retrieved if lost. It couldn't be repaired free of charge under the below conditions:

1. Guarantee period expired. (One year);
2. Damage resulting from using, maintenance, and keeping that are not in accordance with the instruction;
3. Damage resulting from repairing not by the appointed maintenance personnel;
4. Content in guarantee proof is unconfirmed with the label on the real good or be altered;
5. Damage resulting from force majeure.

|                       |   |                           |  |
|-----------------------|---|---------------------------|--|
| Product Name          |  Multi-functional Flow Control Valve for Water Treatment Systems |                           |  |
| Model                 | Code of Valve Body  |                           |  |
| Purchase Company Name | Tel/Cel.  |                           |  |
| Problem               |   |                           |  |
| Solution              |   |                           |  |
| Date of Repairing     | Date of Accomplishment  | Maintenance Man Signature |  |

When product need warranty service, please fill in the below content and sent this card together with the product to the appointed suppliers or Runxin company.

|   |                          |                   |                    |                 |
|---|--------------------------|-------------------|--------------------|-----------------|
| End-user Company Name   |                          |                   | Tel/Cel.           |                 |
| Purchase Company Name   |                          |                   | Tel/Cel.           |                 |
| Model   | Code of Valve Body       |                   |                    |                 |
| Tank Size $\phi$ ×  | Resin Tank Size          | L                 | Raw Water Hardness | mmol/L          |
| Water Source:<br>Ground-water <input type="checkbox"/> Tap Water <input type="checkbox"/> | Water Treatment Capacity | m <sup>3</sup>    | Backwash Time      | min             |
| Brine & Slow Rinse Time   | min                      | Brine Refill Time | min                | Fast Rinse Time |
| Problem Description   |                          |                   |                    |                 |