

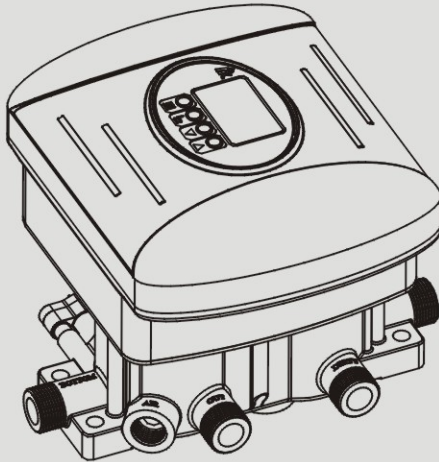

China Patent No.:ZL201020596136.0

Control Valve for Mixed Bed Water Treatment Systems

Model: 15702, 15704



Instruction Manual



Please read this manual in details
before using this valve and keep it properly
in order to consult in the future

0WRX.466.503

MODEL:15702, 15704

Before the valve put into use, please fill in the below content so as to help us to refer in the future.

Mixed Bed System Configuration

Tank Size: Dia. _____ Mm, Height _____ Mm;
Anion Resin Model _____, Volume _____ L;
Cation Resin Model _____, Volume _____ L;
Inlet Water Conductivity _____ μ S/cm;
Inlet Water Na and Si Content _____ μ g/L;
Acid Concentration _____, Alkaline Concentration _____;
Control Valve Model _____.

Parameter Set

Backwash Time _____ Min.; Settling Time _____ Min. ;
Alkaline Drawing Time _____ Min. ;
Acid-Alkaline Drawing Time _____ Min. ;
Acid-Alkaline Rinse Time _____ Min. ;
Drainage Time _____ Min. _____ S. ;
Mixing Time _____ Min; Rapid Rinse Time _____ Min. ;
Fast Rinse Time _____ Min. ;
Middle Drainage D.L.F.C. _____ ;
Backwash D.L.F.C. _____ ; Injector Model _____.

Catalogue

Notice.....	3
1. Product Overview.....	3
1.1. Main Application & Applicability.....	3
1.2. Service Condition.....	4
1.3. Product Characteristics.....	5
1.4. Product Structure.....	5
1.5. Technical Parameters.....	5
1.6. Installation.....	7
2. Basic Setting & Usage.....	11
2.1. The Function of PC Board.....	11
2.2. Basic Setting & Usage.....	12
3. Application.....	14
3.1. Singal System Flow Chart.....	14
3.2. The Function and Connection of PC Board.....	16
3.3. System Configuration and Flow Rate Curve.....	18
3.4. Parameter Settlement.....	19
3.5. Parameter Enquiry and Setting.....	20
3.6. Trial Running.....	23
3.7. Trouble-Shooting.....	23
3.8. Spare Part and Part No.	25
4. Warranty Card.....	30

Notice

- To ensure normal operation of the valve, please consult with professional installation or repairing personnel before use it.
- If there are any of pipeline engineering and electric works, there must be finished by professional at the time of installation.
- Do not use the control valve with the water that is unsafe or unknown quality.
- Do not put the valve near the hot resource, high humidity, corrosive, intense magnetic field or intense vibrations environment. And do not leave it outside.
- Forbidden to carry the injector body. Avoid to use injector body as support to carry the system.
- Forbidden to use the acid or alkali drawing tube or other connectors as support to carry the system.
- Please use this product under the water temperature between 5~50°C, water pressure 0.15~0.6MPa. Failure to use this product under such conditions voids the warranty.
- The acid and alkali system used is strong corrosive liquid. It shall be operated in sealed environment and pay attention to ventilation. It shall be far way from inflammable substance. No smoking, eating or drinking water onsite. Operator shall be trained and follow the operation regulation strictly. It is suggested to wear filtered gas mask, anti-corrosion rubber cloth and glove for operator. After operating, take a shower and change cloth. The polluted cloth should be put individually. System should be carried softly to protect package or container from damage. The usage of acid and alkali shall meet relevant regulation of China.
- Do not let children touch or play, because carelessness operating may cause the procedure changed.
- This valve use methylsiliconeoil as lubricant. It is forbidden to use another lubricant to instead of.
- When the attached cables of this product and transformer are changed, they must be changed to the one that is from our factory.

1. Product Overview

1.1. Main Application & Applicability

Used for intermix of cation and anion resin in one tank as that for a deionization polisher water treatment system.

Be suitable for mixed bed water treatment equipment.

MODEL:15702, 15704

1.2. Service Condition

Runxin Valve should be used under the below conditions:

Items		Requirement
Working conditions	Water pressure	0.15MPa~0.6MPa
	Water temperature	5°C~50°C
	Compressed air pressure	0.1~0.15MPa(G)
	Compressed air cleanliness	No oil, no dust.
	HCL/NaOH concentration	10%
	Environment temperature	5°C~50°C
	Relative humidity	≤ 95% (25°C)
	Electrical facility	AC100~240V/50~60Hz
	System far away from heat sources or surroundings with, corrosive intense magnetic field or intense vibrations. And install it indoors.	
Density difference of wet cation resin and anion resin		15%~20%
Inlet water quality	Water conductivity	≤ 10 μ S/cm
	Water Na & Si content	≤ 100 μ g/L

Note: If you have any special requirement , please contact with us.

1.3. Product Characteristics

➤Simple structure and reliable sealing

It adopts hermetic head faces with high degree pottery and corrosion resistance for opening and closing. It combines Service, Backwash, Settling, Acid-Alkaline Pre-drawing, Acid-Alkaline Drawing, Drainage, Mixing and Fast Rinse.

➤Manual function

Realize regeneration immediately by pushing manual button at any time.

➤Long outage indicator

If outage overrides 3 days, the time of day indicator will flash to remind the user to reset the present time. The other set parameters do not need resetting. The process will continue.

inue to work after power on.

➤ **Buttons lock**

No operations to buttons within 1 minute, button lock indicator light on which represent buttons are locked. Before operation press and hold both the ▲ and ▼ buttons for 5 seconds to unlock. This function can prevent incorrect operation.

➤ **Signal output**

There is a signal output connector on main control board. It could control the booster pump on inlet of first and second grade demineralization system.

➤ **Remote handling input**

This connector can receive external signal, used together with PLC, computer, conductivity, resistivity etc. to control the valve.

➤ **All parameters can be modified**

According to the water quality and usage, the parameters in the process can be adjusted.

➤ **Fast rinse first in case of stopping in service or power reconnected.**

Fast rinse first in case of stopping in service or power reconnected to avoid unqualified water entering into equipment.

At the end of Backwash, interval open and shut-off water inlet to increase the effect of cation and anion resin layering.

At the last minute of Backwash, interval 15 seconds to open and shut-off water inlet to increase the effect of cation and anion resin layering.

➤ **Online monitory outlet water quality**

A resistivity meter is installed on the water outlet. In service position, if the resistivity of outlet water is unqualified for more than 20 seconds continuously, the system needs regeneration. In fast rinse position, if the resistivity of outlet water is qualified for more than 1 minute continuously, they system can turn to the service position.

➤ **Multi-type programs for option**

Mixed bed system can select either single system operation or one valve in service one standby operation.

The single system has two types of operation programs:C-01 and C-02.It can be selected in program.

When system set as C-01, use first grade demineralization to regenerate, while set C-02, use second grade demineralization to regenerate.

Use a cable connecting two control valves for mixed bed. Program will automatically Adjust to be one valve in service one standby. Use first grade or second grade demineralization to regenerate.

1.4. Product Structure

A. Product dimensions (The appearance is just for reference. It is subject to the real product.)

MODEL:15702, 15704

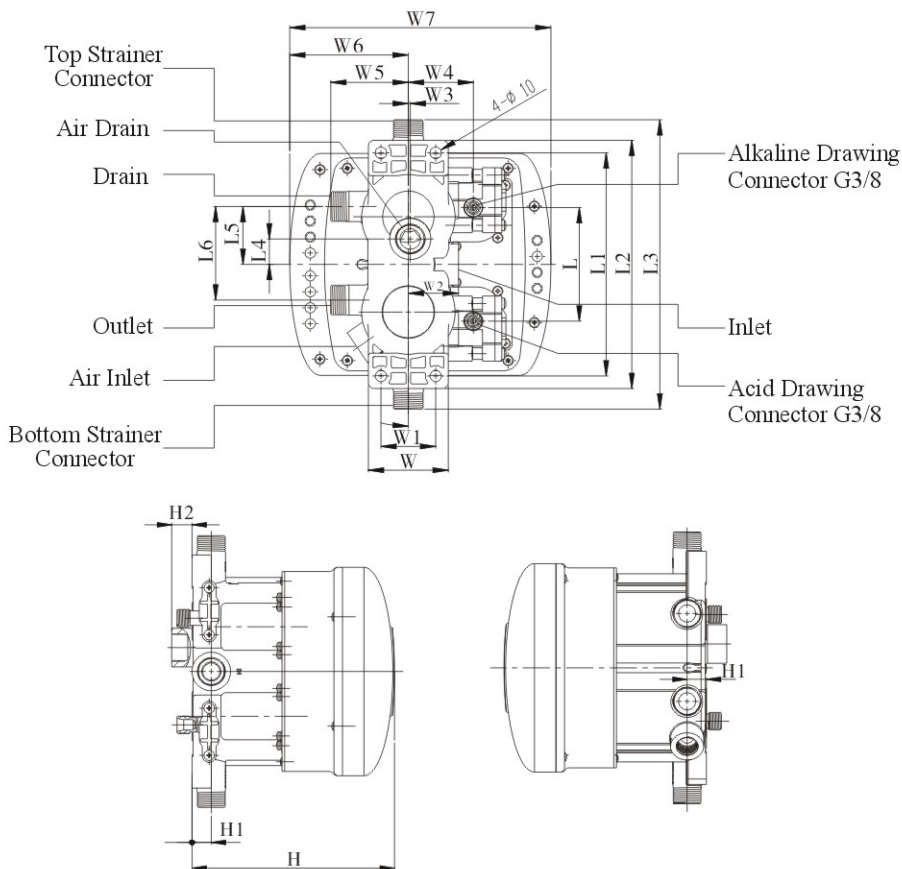

Control Valve Model	W	W1	W2	W3	W4	W5	W6	W7	L
15702	70	48	44	1.7	57	68	104	229	99.5
15704	82	60	71	3	67	84	94	229	126
Control Valve Model	L1	L2	L3	L4	L5	L6	H	H1	H2
15702	195.5	217.5	253.5	22.3	50.7	82	189	18	37
15704	213	235	285	26.5	64.5	101	199.5	23.5	34.5

MODEL:15702, 15704

1.5. Technical Parameters

A. Main Technical Parameters

Control Mode	Online Monitoring	Compressed Air Pressure	0.1MPa(G)
Electrical Facility Input	100-240V ~ 50/60Hz	Mixed bed size	8" ~ 12"
Electrical Facility Output	DC12V, 2A	Water treatment capacity	2 m ³ /h
Water Pressure	0.15 ~ 0.6MPa	HCL concentration	10%
Water Temperature	5 ~ 50℃	NaOH concentration	10%
Inlet Water Quality	Conductivity ≤ 10 μ S/cm Na & Si content ≤ 100 μ g/L	Regeneration liquid concentration	HCL: 3% ~ 5%; NaOH: 2% ~ 4%

B. Control valve connector size

Model	Inlet	Outlet	Drain	Top Strainer Connector
15702	3/4" F	3/4" M	3/4" M	3/4" M
15704	1" M	1" M	3/4" M	1" M
Model	Bottom Strainer Connector	Acid-Alkaline Drawing Connector	Air Inlet	Air Drain
15702	3/4" M	3/8" M	1/2" F	3/4" F
15704	1" M	3/8" M	1/2" F	3/4" F

Note: M—Male Thread F—Female Thread

1.6. Installation

A. Installation notice

Before installation, read all the instructions completely. Then obtain all materials and tools needed for installation.

The installation of product, pipes and circuits, should be accomplished by professional to ensure the product can operate normally.

Perform installation of control valve for mixed bed system according to the relative pipeline regulations and the specification of Water Inlet, Water Outlet, Drain Outlet, Acid Drawing Connector, Alkaline Drawing Connector, Air Inlet.

B. Device location

①The distance between the middle drain pipeline, bottom drain pipeline, drain pipeline, air drain pipeline should be as short as possible, not longer than 3 meters. The pipeline should

MODEL:15702, 15704

not be higher than each drain connector. It is allowed to collect each drain connector to be one total drain (Except air drain pipeline). But the total drain pipeline should not be higher than the bottom drain connector. The total drain pipeline is connected with sewer.

- ② Ensure the unit is installed in enough space for operating and maintenance.
- ③ Acid or alkaline tank need be close to mixed bed system in well-ventilated surroundings. It should match acid mist absorber.
- ④ The unit should be kept away from heat sources and not be exposed outdoors. Sunshine or rain will cause the system damage.
- ⑤ Please avoid to install the system in one Acid/Alkaline, Magnetic or strong vibration circumstance, because above factors will cause the system disorder.
- ⑥ Do not install the unit, drain pipeline in surroundings where temperature is lower than 50°C, or higher than 50°C.
- ⑦ One place is recommended to install the system which cause the minimum loss in case of water leakage.



- The distance between system outlet and boiler pipeline should be longer than 3 meters.
- The distance between each drain pipeline and sewer should be about 20mm.
- If system use soldering method to assemble pipeline, soldering first, after it cooling then connect it to main valve.
- Use pipe hanger to support all pipelines.
- Forbidden over-stress to tighten pipeline, otherwise the, thread or valve body will be damaged.

C. Pipeline installation

System with control valve installation, as Figure 1.

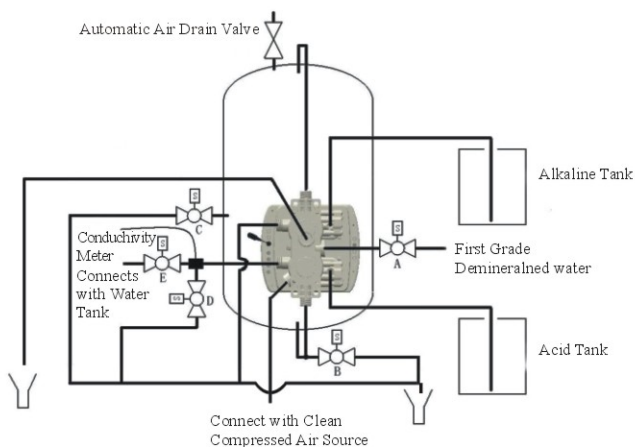

Figure 1 System installation

①Fix control valve

A pipe hanger should be soldered to support mix control valve. The hanger needs to be close to the mixed bed tank and 1~1.5 meter high from floor. The hanger structure and installation holes can be designed according to the valve's appearance and installation drawing.

Use stainless steel bolt to fix control valve on the soldered hanger.

②Installation of top and bottom strainer, bottom drain.

Assemble top strainer connector of control valve to top strainer connector of tank. Assemble a tee valve on bottom strainer connected of tank, one port connected with bottom strainer connector of control valve, one port connected with an electronic ball valve B as bottom drain. Any elbow should not be higher than bottom drain, as figure 2 showing.

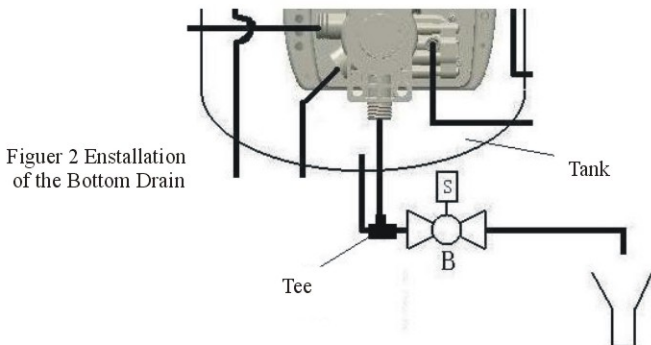

Figure 2 Enstallation of the Bottom Drain

③Inlet pipeline installation

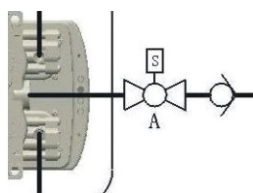

Figure 3 Single system operation first grade demineralization for regeneration

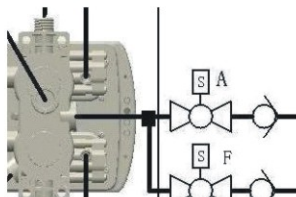

Figure 4 Single system or one in service one standby operation second grade demineralization for regeneration

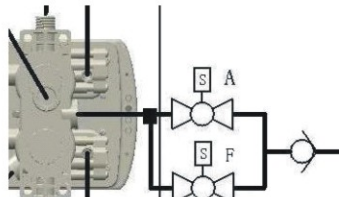

Figure 5 One in service one standby operation first grade demineralization for regeneration

MODEL:15702, 15704

According to the design requirements, if the single system uses first grade demineralized water for regeneration, program set as C-01, the inlet installation as figure 3 showing. If the single system or one in service one standby uses second grade demineralized water for regeneration, the inlet installation as figure 4 showing. Single system uses first grade demineralized water for regeneration, program set as C-02, it can not assemble electronic ball valve F. One in service one standby uses first grade demineralized water for regeneration, the inlet installation as figure 5 showing.

④Installation of water outlet, drain and conductivity meter.

As figure 6 showing, two piece of tee valves connect valve outlet with conductivity meter, electronic ball valve D and E. E is qualified water outlet. D is the drain connector of fast rinse. D should be put a fast rinse flow control washer.

⑤Air inlet installation

When valve is in mixing status, it needs clean and oil-free compressed air from the bottom of tank to mix anion and cation resin. Compressed air intensity is $2\sim 3\text{m}^3/\text{m}^2\cdot\text{min}$., and it should be oil-free protect resin from pollution.

Use a tube connecting air inlet with the compressed air source.

⑥Acid-alkaline drawing pipeline installation

As figure 7 showing, use a $\Phi 6.5$ anti-acid and alkaline tee soft tube to connect acid tank with acid drawing connector. One port insert tube bushing, then connect with acid drawing connector, another port connect with acid tank.

Use an anti-acid and alkaline tee soft tube to connect alkaline tank with alkaline drawing connector. One port insert tube bushing, then connect with alkaline drawing connector, another port connect with alkaline tank.

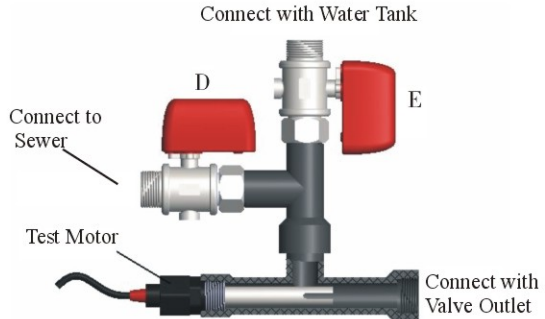

Figure 6 Installation of Water Outlet and Conductivity Meter

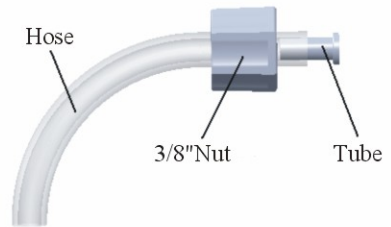

Figure 7 Installation of Acid-alkaline Drawing Pipeline

MODEL:15702, 15704

⑦ Middle drain pipeline installation

Connect electronic ball valve C with middle drain connector. Assemble a check valve for adjusting drain flow rate in a proper location of outlet pipeline of C. The waste water shall be drained to a big container. Forbidden any elbow higher than middle drain port.

The drainage of waste water shall meet relevant national drainage regulations.

⑧ Backwash drain pipeline installation

As figure 8 showing, install backwash D.L.F.C. on a proper location on drain pipeline and forbidden any elbow higher than the drain port.

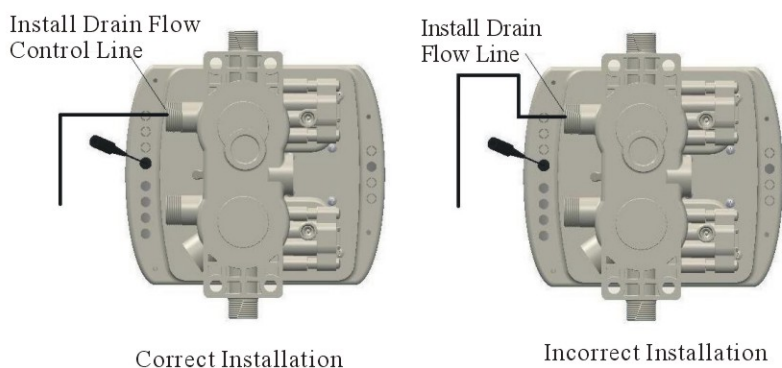

Figure 8 Backwash drain pipeline installation

⑨ Air drain pipeline installation

When mixing resin, there will be air and water flowing out from the air drain. The waste water shall be drained to sewer.

⑩ Other equipment installation

Install acid and alkaline groove in acid and alkaline tank. Install acid mist absorber equipment.

2. Basic Setting & Usage

2.1. The Function of PC Board

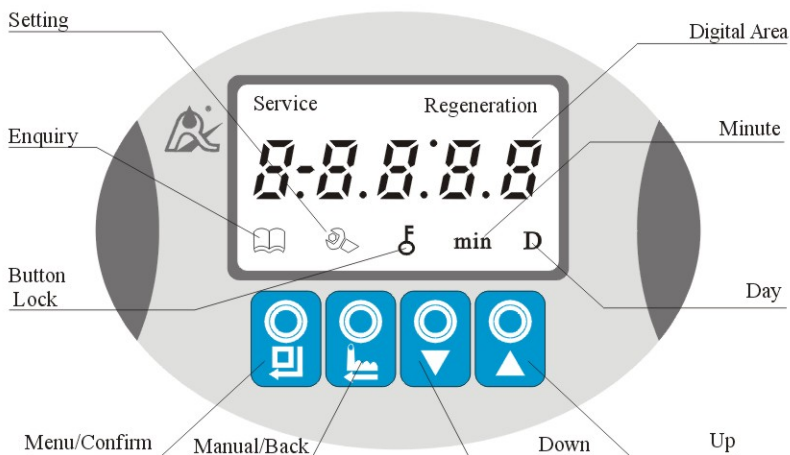

A. Button lock indicator

● Light on, indicates the buttons are locked. At this moment, no single button will work (operation in one minute, will light on and lock the buttons.)

● Solution: Press and hold both and for 5 seconds until the light off.

B. Program display mode

● Light on, enter program display mode. Use or to view all values.

C. Program set mode indicator

● Light on, enter program set mode. Press or to adjust values.

D. Menu/Confirm button



● Press , light on, enter the program display mode and use or to view all values.

● In the program display mode, press , flash, enter program set mode, press or and adjust values.







● Press after all program are set, and then the voice “Di” means all setting are successful and return to program display mode.

E. Manual/Return button

● Press in any status, it can proceed to the next step. (For example: When outlet water is unqualified, lift up the buttons, then press to start regeneration. In regeneration cycle, if you want to finish one step in advance, press to enter into next step.)

- Press  in the program display mode, and it will return to Service Position; Press  in program set mode, and it will return to the program display mode.
- Press  while adjusting the value, then it will return to the program display mode directly without saving value.

F.Down  and Up 

- In program display mode, press  or  to view all values.
- In program set mode, press  or  to adjust values.
- Press and hold both  and  for 5 seconds to unlock the buttons.

2.2. Basic Setting & Usage

A. Single system operation parameter specification

Function	Showing	Factory Default	Parameter Set Range	Instruction
Time of Day		Random	00:00 ~ 23:59	Set the time of day when in use; “:” flashes
Regeneration Time		02:00	00:00 ~ 23:59	Regeneration time; “:” light on
Service Days	1-60 D.	60	0 ~ 99	1----Service position, D---Days
Backwash	2-05 min.	5	0 ~ 60	Backwash time(Minute)
Settling	3-03 min.	3	0 ~ 99	Settling time(Minute)
Alkaline Drawing	4-35 min.	35	0 ~ 99	Alkaline drawing time (Minute)
Acid-Alkaline Drawing	5-65 min.	65	0 ~ 99	Acid-Alkaline drawing time (Minute)
Acid-Alkaline Rinse	6-30 min.	30	0 ~ 99	Acid-Alkaline rinse time (Minute)
Drainage	7-00 : 07 min.	0:7	0 ~ 10	Drainage time (Minute: Second)
Mixing	8-00 : 40 min.	0:40	0 ~ 10	Mixing time (Minute: Second)
Rapid Drain	9-00 : 10 min.	0:10	0 ~ 10	Rapid drain time (Minute: Second)
Fast Rinse	A-10 min.	10	0 ~ 60	Fast rinse time (Minute)
Water for Regeneration	C-01	01	C-01/02	C-01: Use first grade demineralized water for regeneration. C-02: Use second grade demineralized water for regeneration.

MODEL:15702, 15704

B. Operation parameter specification for one in service one standby

One in service one standby has no item of “Fast Rinse” and “Water for Regeneration”, but has additional items of “Fast Rinse 1”, “Waiting” and “Fast Rinse 2” as below

Function	Showing	Factory Default	Parameter Set Range	Instruction
Fast Rinse 1	A1-10min.	10min.	0 ~ 60min.	“A1” --- “Fast Rinse 1”
Waiting	A2-dd.	/	/	“A2” --- “Waiting”
Fast Rinse 2	A3-10min.	10min.	0 ~ 60min.	“A3” --- “Fast Rinse 2”



Figure A



Figure B



Figure C

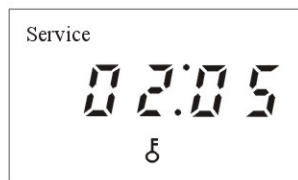

Figure D

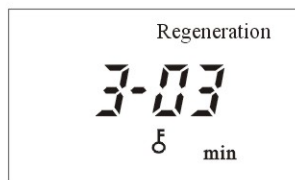

Figure E

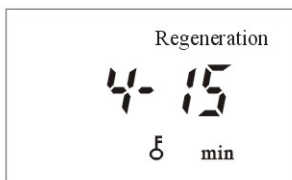

Figure F

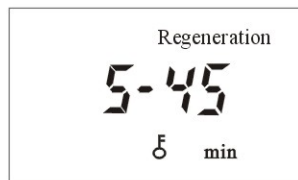

Figure G

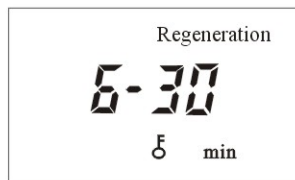

Figure H

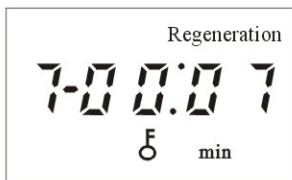

Figure I

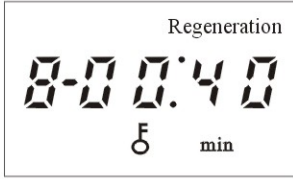

Figure J



Figure K

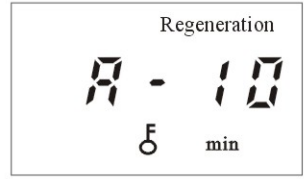

Figure L

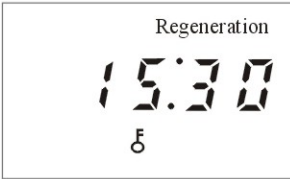

Figure M

Illustration:

- Circular Display of Service Position: Figure A/B/C;
- Circular Display of Backwash Position: Figure D/M;
- Circular Display of Settling Position: Figure E/M;
- Circular Display of Alkaline Drawing: Figure F/M;
- Circular Display of Acid-alkaline Drawing: G/M;
- Circular Display of Acid-alkaline Rinse: H/M;
- Circular Display of Drainage: I/M;
- Circular Display of Mixing: Figure J/M;
- Circular Display of Rapid Drain: Figure K/M;
- Circular Display of Fast Rinse: Figure L/M.
- When the motor is rotating or the electronic valve is working, the display board only shows “-00-”
- When the time of day flash continuously, such as “2:12” , it indicates long outage of power. It reminds the user to reset the time of day.
- Working Process: Service→Backwash→Settling→Alkaline Drawing→Acid-alkaline Drawing→Acid-alkaline Rinse→Drainage→Mixing→Rapid Drain→Fast Rinse
- When the system in error, the display board will show the error code, such as “-E1” .
- If the system loses power in service position, it goes into fast rinse when power is reconnected and judge if water is qualified. If qualified, it goes into service status; in case unqualified, then it goes into backwash status.

3. Applications

3.1. Single System Flow Chart

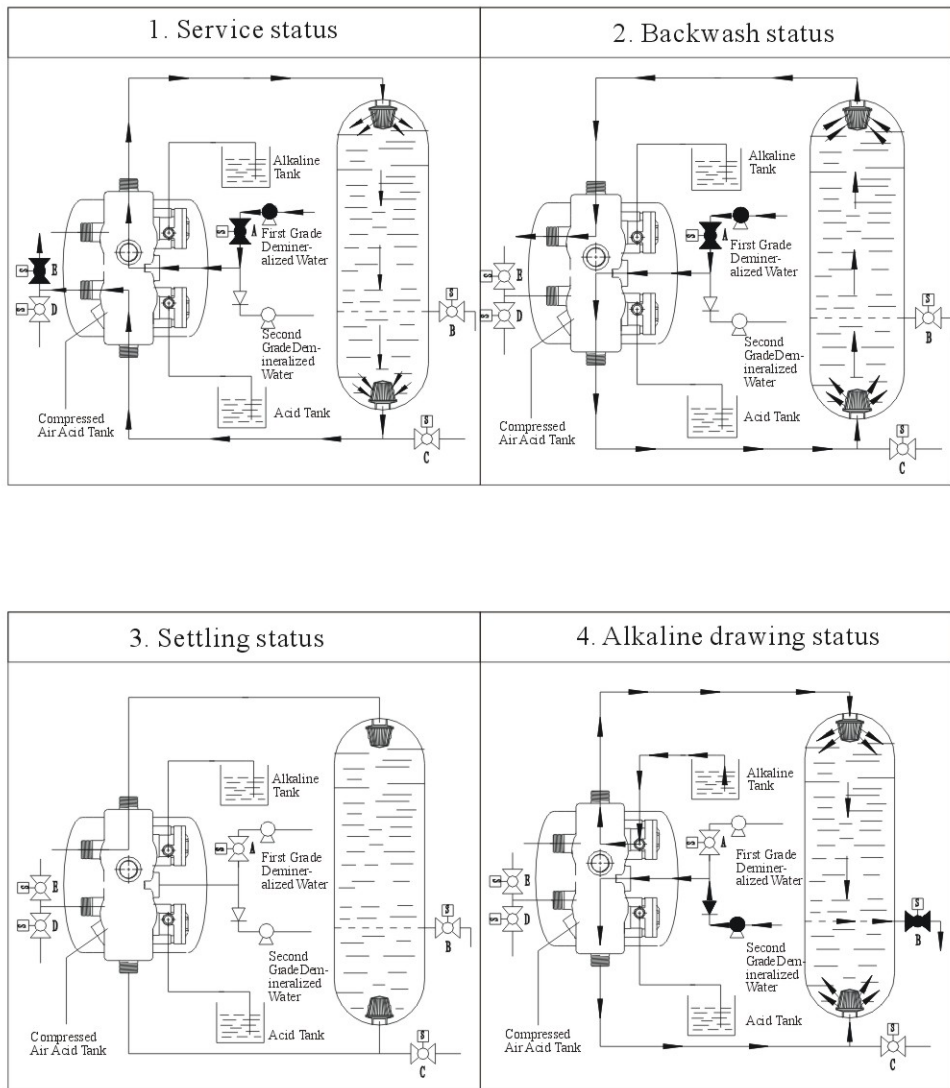

MODEL:15702, 15704

5. Acid-Alkaline drawing status

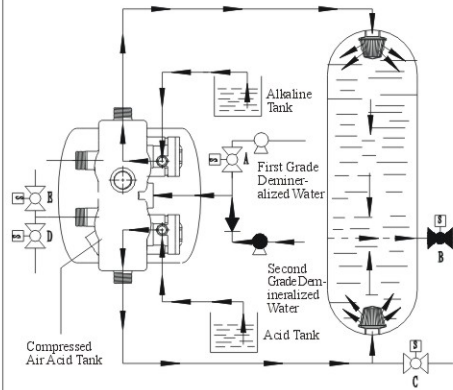

6. Acid-Alkaline rinse status

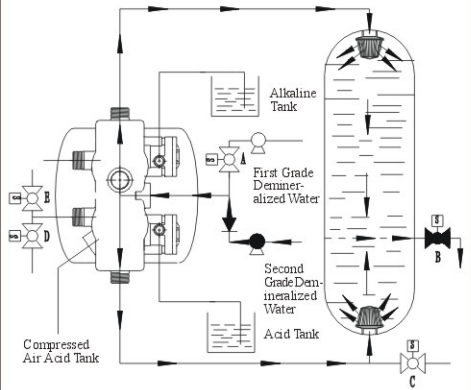

7. Drainage status

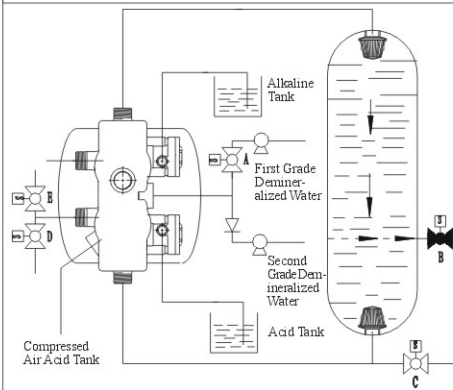

8. Mixing status

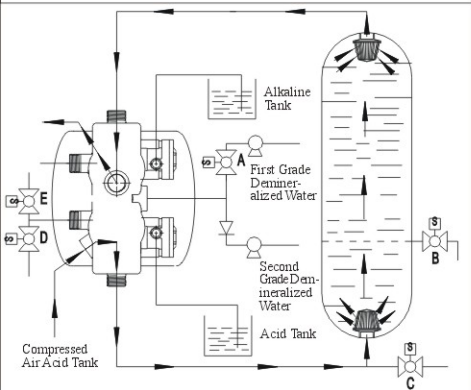

9. Rapid drain status

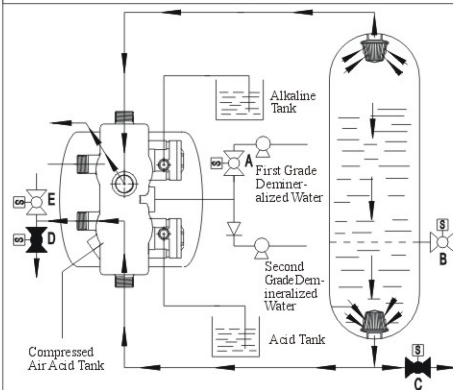

10. Fast rinse status

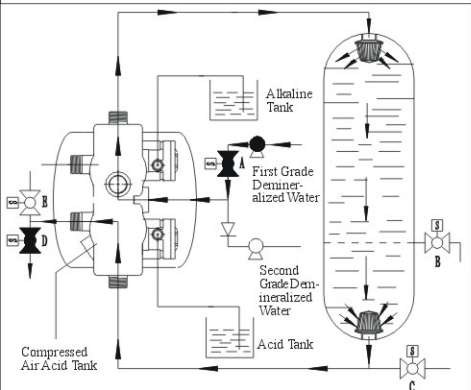

3.2. The Function and Connection of PC Board

Main control board and connection port as figure 9:

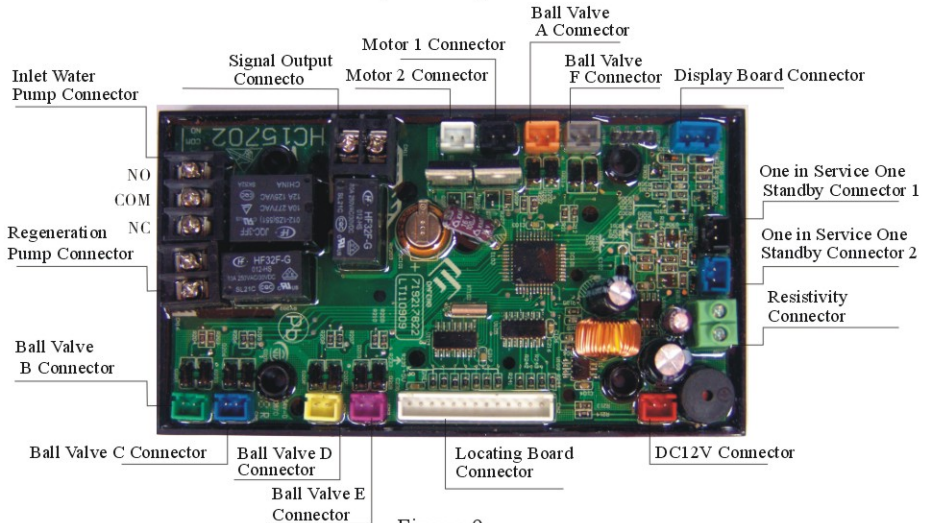

Figure 9

A. Wiring of Booster Pump on Inlet

If inlet water pressure is less than 0.15MPa, a booster pump is suggested to be installed on the inlet. There is an inlet pump connector socket on main control board to connect with a booster pump. The wiring is as figure 10.

If inlet booster pump current is bigger than 5A, it could connect a 220V AC contactor to control the inlet booster pump. The wiring is as figure 11.

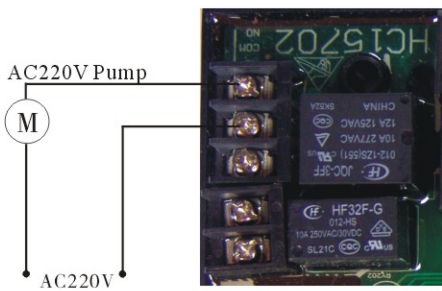

Figure 10

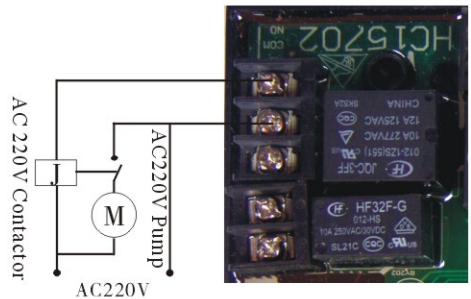

Figure 11

B. Wiring of regeneration pump

If the system uses second grade demineralization for regeneration, it needs to install a regeneration inlet pipeline in parallel. The pipeline is as figure 4, regeneration pump connect with mixed bed tank (which is second grade demineralization tank). There is a regeneration pump connector on main control board to connect with regeneration pump. The wiring is as figure 12.

If inlet booster pump current is bigger than 5A, it could connect a 220V AC contactor to control the inlet booster pump. The wiring is as figure 13.

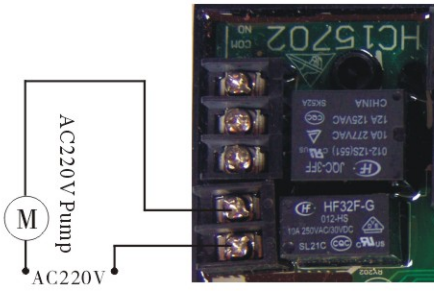

Figure 12

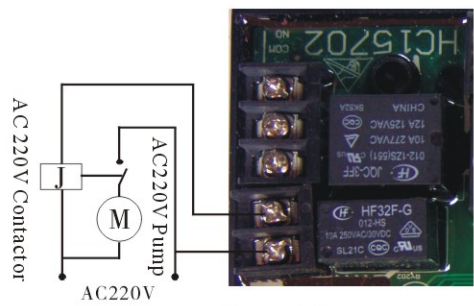

Figure 13

C. Wiring of resistivity meter

Connect two wires respectively to the J1, J0 connectors which are on the back of resistivity meter, then connect the two wires respectively to the resistivity meter connector on main control board. The wiring is as figure 14. J1 and J0 are passive switch.

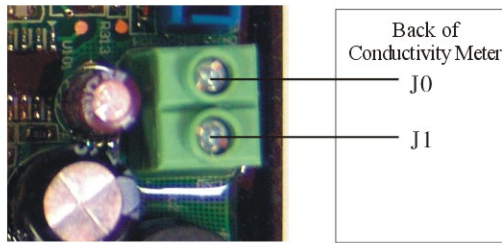

Figure 14

D. Wiring of electronic ball valve

The wiring of electronic ball valve is connecting electronic ball valves showing in figure 1 with connectors on main control board showing in figure 9.

E. Wiring of one in service one standby

The wiring of one in service one standby is as figure 15. If the system uses first grade demineralization for regeneration, the inlet pipeline is as figure 5, which doesn't need to match the regeneration pump.

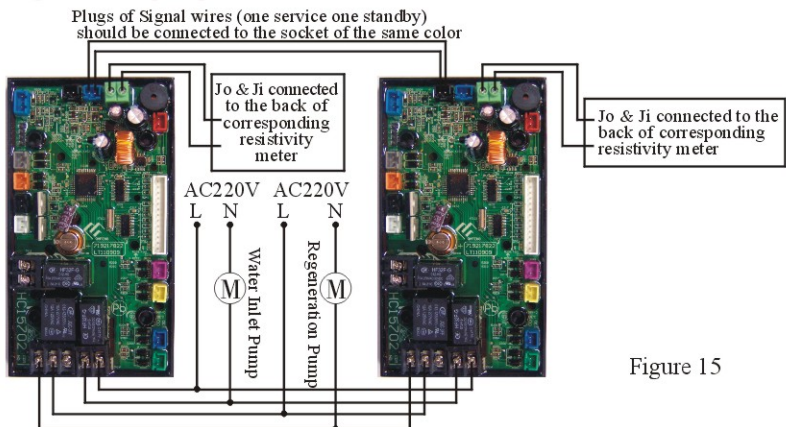

Figure 15

MODEL:15702, 15704

3.3. System Configuration and Flow Rate Curve

A. Product Configuration

Tank Size mm	Cation Resin Volume (L)	Anion Resin Volume (L)	Flow Rate (t/h)	Acid Tank Size mm	Alkaline Tank Size mm	Injector Model
φ 250×2000	20	40	1.2	φ 400×800	φ 400×800	6301
φ 300×2000	35	70	2	φ 400×800	φ 400×800	6302
φ 350×2200	48	96	3	φ 500×800	φ 500×800	6304
φ 400×2200	62	124	4	φ 500×800	φ 500×800	6305

B. Flow Rate characteristic

1). Pressure-flow rate curve

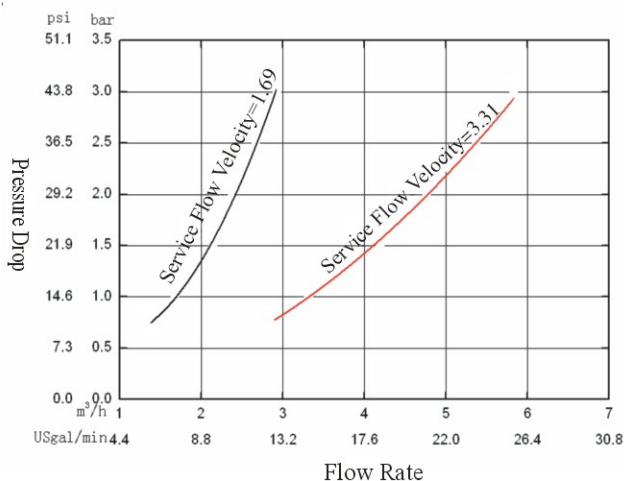

Note: The flow rate is tested under different inlet pressures, normal water temperatures, normal outlet pressures.

2) Injector parameter table

Inlet Pressure MPa		0.15	0.2	0.25	0.3	0.35
Draw Rate (L/M,30%)	6301 Coffe	0.81/0.24	0.95/0.28	0.99/0.3	1.3/0.39	1.45/0.43
	6302 Pink	1.12/0.33	1.41/0.42	1.61/0.48	1.81/0.54	1.96/0.59
	6303 Yellow	1.58/0.47	1.87/0.56	2.08/0.62	2.18/0.65	2.39/0.72
	6304 Blue	2.21/0.66	2.53/0.76	2.79/0.84	3.05/0.91	3.27/0.98
	6305 White	2.45/0.73	2.89/0.87	3.3/0.99	3.66/1.1	3.94/1.18
	6306 Black	3.3/0.99	3.88/1.16	4.3/1.29	4.74/1.42	5.02/1.5
	6307 Purple	3.44/1.03	4.21/1.26	4.66/1.4	5.15/1.54	5.55/1.66

3). Acid-alkaline and drain line flow control matching

Tank Size mm	10%HCL Consume per Time (Kg)	10%NaOH Consume per Time (Kg)	D.L.F.C.	Fast Rinse D.L.F.C.
φ250 × 2000	25	50	1#	1#
φ300 × 2200	36	72	2#	2#
φ350 × 2200	48	96	3#	3#
φ400 × 2200	60	120	4#	4#

Note: The above matching table is only for reference. Water is used as the media for the testing. 10%HCL and 10%NaOH consume is calculated based on concentration 3% of HCL and NaOH after drew into injector and volume is three times that of resin volume.

3.4. Parameter settlement

①Service time T1

Anion resin water treatment capacity:

$$Q_-=V_{R-} \times E_- \div Y_{D-} \quad (m^3)$$

Y_{D-} Anion content in inlet water, mmol/L
 E_- Anion resin working exchange capability, 300~450mmol/L
 V_{R-} Anion resin volume, m³

Cation resin water treatment capacity:

$$Q_+=V_{R+} \times E_+ \div Y_{D+} \quad (m^3)$$

Y_{D+} Cation content in inlet water, mmol/L
 E_+ Cation resin working exchange capability, 800~1500mmol/L
 V_{R+} Cation resin volume, m³

Generally, $V_{R-}=2V_{R+}$

Mixed bed system water treatment capacity: $Q=\text{MIN}(Q_-, Q_+)$, (Q_- and Q_+ take the minimal values.)

By hours: $T1=Q \div Q_h$ (hour)

Q_h Water treatment capacity per hour, m³/h
 Q Water treatment capacity, m³

By days: $T1=Q \div Q_d$ (day)

Q_d Water treatment capacity per day, m³/d
 Q Water treatment capacity, m³

②Tank diameter D:

$$D=(4Q_h \div (V \times \Pi))^{1/2}$$

Q_h Service flow rate, generally 40~60 m/h
 V Water usage per hour, m³/h

③Resin height:

Cation resin height: $H_{R+}=4V_{R+}/\Pi D^2$

Anion resin height: $H_{R-}=2H_{R+}$

④Reagent consume per regeneration:

$$m_z = \frac{V_R \times E \times k \times M}{10^3 \varepsilon}$$

In this formula:

m_z — Reagent consume per regeneration, Kg;

V_R — Resin volume in tank, m^3 ;

E — Resin working exchange capability, generally, cation resin take 800~1500 mol/m^3 , anion resin take 300~450 mol/m^3 .

K — Reagent consume, generally take 2~3.5.

M — Reagent molar mass, HCl take 36.5, NaOH take 40.

ε — Reagent purity, generally, industrial strong HCl and NaOH account for 30%~33%.

⑤ Reagent entering time when regeneration t:

$$t = \frac{60m_z}{S \times v \times C \times \rho \times 10^3}$$

In this formula:

m_z — Reagent consume per regeneration, Kg;

S — Section surface in tank, m^2 ;

F — Low rate of reagent, 2~5 m/h ;









C — Reagent concentration, HCL: 3%~5%, NaOH: 2%~4%;

ρ — Reagent consistency, 3% HCl consistency is 1.05 Kg/m^3 , 2% NaOH consistency is 1.02 Kg/m^3 .

Note: The calculation of parameters for each step is only for reference, the actual proper time will be determined after adjustment by the complete system supplier.

3.5. Parameter Enquiry and Setting

3.5.1. Parameter Enquiry

When  light on, press and hold both  and  for 5 seconds to unlock; press ,  will light on, and enter the program display mode: press  and  to view each value according to the below process. (Press  to exit and turn back to service status). The single system program display flowchart:























































Enquiry flowchart of the duplex One Service One Standby:

























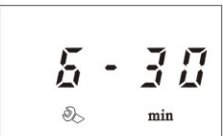



















3.5.2. Parameter Setting

In the program display mode, press  and enter into the program set mode. Press  or  to adjust the value.













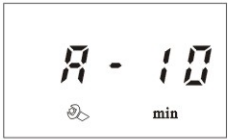

3.5.3. The steps of parameter setting

Items	Process steps	Symbol
Time of Day	<p>When time of day "12:12" continuously flash,it reminds the user to reset:</p> <p>1.Press  to enter the program set mode;  light on, ":" flashes, then press  to enter the time of day setting mode, both  and hour value flash, then press  or  to adjust the hour value.</p> <p>2.Press , both  and minute value flash, then press  or  to adjust the minute value.</p> <p>3.Press  to finish setting the time of day, then press  to turn back.</p>	
Regeneration Time	<p>1 .In regeneration time display status, press  to enter the program set mode,  light on and "02" flashes, then press  or  to adjust the hour value;</p> <p>2. Press , "00" flashes, then press  or  to adjust the minute value;</p> <p>3. Press  to finish setting the regeneration time, and press  to turn back.</p>	
Service Days	<p>1 .In service days display status, press  to enter the program set mode, it shows "1-03" ,  light on and "03" flashes,</p> <p>2. Press  or  to adjust the day value;</p> <p>3. Press  to finish setting the regeneration days, and press  to turn back.</p>	
Backwash Time	<p>1 .In backwash time display status, press  to enter the program set mode, it shows "2-03" ,  light on and "2" flashes, then press  or  to adjust the day value;</p> <p>2. Press , "03" flashes, then press  or  to adjust the minute value;</p> <p>3. Press  to finish setting the regeneration time, and press  to turn back.</p>	
Settling Time	<p>1. In settling time display status, it shows "3-03", press  to enter the program set mode,  light on and "03" flashes.</p> <p>2. Press  or  to adjust the settling time;</p> <p>3. Press  to finish setting the regeneration time, and press  to turn back.</p>	
Alkaline Pre-drawing Time	<p>1. In alkaline pre-drawing time display status, it shows "4-15" , press  to enter the program set mode,  light on and "15" flashes,</p> <p>2. Press  or  to adjust the alkaline pre-drawing time;</p> <p>3. Press  to finish setting the alkaline pre-drawing time, and press  to turn back.</p>	

MODEL:15702, 15704

<p>Acid-Alkaline Drawing Time</p>	<p>1. In acid-alkaline washing time display status, it shows "5-45", press  to enter the program set mode,  light on and "45" flashes, 2. Press  or  to adjust the acid-alkaline washing time; 3. Press  to finish setting the alkaline-drawing time, and press  to turn back.</p>	
<p>Acid-Alkaline Rinse Time</p>	<p>1. In acid-alkaline washing time display status, it shows "6-30", press  to enter the program set mode,  light on and "30" flashes, 2. Press  or  to adjust the acid-alkaline washing time; 3. Press  to finish setting the alkaline-drawing time, and press  to turn back.</p>	
<p>Drainage Time</p>	<p>1. In drainage time display status, it shows "7-00:30", press  to enter the program set mode,  light on and "00" flashes. Press  or  to adjust the minute value; 2. Press , "30" flashes, press  or  to adjust the second value; 3. Press  to finish setting the drainage time, and press  to turn back.</p>	
<p>Mixing Time</p>	<p>1. In mixing time display status, it shows "8-00:40", press  to enter the program set mode,  light on and "00" flashes; 2. Press  or  to adjust the minute value; 3. Press  , and press  or  to adjust the second value; 4. Press  to finish setting the mixing time, and press  to turn back.</p>	
<p>Rapid Drain Time</p>	<p>1. In rapid drain time display status, it shows "9-00:10", press  to enter the program set mode,  light on and "00" flashes, 2. Press  or  to adjust the rapid drain minute value; 3. Press  , and then  or  to adjust the rapid drain second value; 4. Press  to finish setting the rapid drain time, and press  to turn back.</p>	

MODEL:15702, 15704

Fast Rinse Time	<ol style="list-style-type: none">1. In fast rinse time display status, it shows "A-10", press  to enter the program set mode,  light on and "10" flashes;2. Press  or  to adjust the fast rinse time;3. Press  to finish setting the fast rinse time, and press  to turn back.	
Water for Regeneration Mode	<ol style="list-style-type: none">1. In water for regeneration mode display status, it shows "C-01", press  to enter the program set mode,  light on and "01" flashes,2. Press  or  to select 01 or 02;3. Press  to finish setting the water for regeneration mode, and press  to turn back.	

3.6. Trial running

A. Installation, pipeline and gauge engineering shall be operated by the professional. After cleaning the equipment and pipeline, please check and maintain the following items.

B. Make sure the actual working condition meet the requirements of control valves.

C. After setting the technical parameters, use water instead of acid and alkaline. Start the system and make the water pressure test. Ensure all connecting is free of leakage.

D. When system in service, check if each position of valve and media flow is correct and if acid-alkaline injector could draw water normally. Adjust drain flow rate via a middle drain check valve. Adjust each parameter to comply with the requirement. Ensure that in the status of alkaline drawing, acid-alkaline drawing and rinse, the water level is 100 mm higher than anion resin level. The best level is 100~150mm, but the if level is over-high, it makes waste of alkaline and difficult rinse.

E. After shutting down the system, refill acid and alkaline into each tank. Restart system, regenerate and trial running. Adjust each parameter depending on practical application. Check flow rate and outlet quality. If they comply with the requirements, the system can be put into use

3.7. Trouble-Shooting

A. Control Valve Fault

Problem	Cause	Correction
1.Mixed bed fails to regenerate.	A. Electricity to the system are cut off . B. Regeneration cycles are set incorrect. C. Controller is defective.	A. Check the electricity supply service(Check fuse, plug, pull chain or switch). B. Reset regeneration cycles. C. Replace controller.
2.Repeat regeneration, no high purity water passing, display show —E5—	A. No acid and alkaline in tanks. B. Injector plugged. C. Resin layering improper. D. Resin mixing insufficient. E. Resin failure. F. Resistivity meter damaged. G. Internal valve leak. H. Controller damaged. I. Inlet water quality become worse.	A. Check and ensure acid and alkaline in tanks. B. Change or clean injector. C. Check if drain pipeline is plugged and if each parameter is correct. D. Check the pressure of compress air and the pipeline. E. Change resin. F. Clean or change sensor. G. Change valve body. H. Change controller. I. Check the above demineralization equipment and raw water quality.
3.Mixed bed fails to draw acid-alkaline.	A. Inlet pressure is too low. B. Acid-alkaline line is blocked. C. Acid-alkaline line is leaking. D. Injector damaged. E. Internal control leak. F. Middle drain pipeline is plugged.	A. Increase inlet pressure. B. Clean acid-alkaline line. C. Replace acid-alkaline line. D. Change injector. E. Replace valve body. F. Clean middle drain pipeline.
4.Pressure lost.	A. Pipeline is blocked or leaking. B. Strainer is blocked.	A. Clean or replace the pipeline. B. Clean or replace the strainer.
5.Loss of mineral through drain line.	A. Air in water system. B. Strainer broken.	A. Assure that well system has proper air eliminator control. B. Replace the strainer.
6.Control cycle continuously.	A. Locating signal wiring breakdown. B. Controller is faulty. C. Foreign material stuck the driving gear.	A. Check and connect locating signal wiring. B. Replace the controller. C. Take out foreign material.
7.Drain flows continuously.	A. The Internal valve leak. B. Electricity fails to supply during backwash or fast rinse position.	A. Check and fix the valve body or replace it. B. No need to handle it.

B. Controller Fault

Problem	Cause		Correction
1. All indicators display on front panel.	A. Wiring of display board with controller fails to work. B. Control board is faulty. C. Transformer dampened or damaged.		A. Check and replace the wiring. B. Replace the control board. C. Check and replace transformer.
2. No display on the front panel.	A. Wiring of display board with control board fails to work. B. Display board is faulty. C. Control board is damaged. D. Electricity is interrupted.		A. Replace the wiring B. Replace the display board C. Replace the control board D. Check the electricity supply.
3. E1 Flash	A. Wiring of locating board with control board fails to work. B. Locating board damaged. C. Mechanical transmission devices damaged. D. Faulty control board. E. Wiring of Motor 1 and control board is faulty. F. Motor damaged.		A. Replace the wiring B. Replace the control board. C. Check the mechanical transmission devices. D. Replace the control board. E. Replace the wiring of motor 1.
4. E2 Flash	A. Wiring of locating board and control board is faulty. B. Locating board damaged. C. Mechanical transmission devices damaged. D. Control board damaged. E. Wiring of motor 2 and control board is faulty. F. Motor 2 damaged.		A. Replace the wiring. B. Replace the locating board. C. Check the mechanical transmission devices. D. Replace the control board. E. Replace wiring of motor 2. F. Replace motor 2.
5. E12 or E22 flash	A. Holzer components on locating board damaged. B. Wiring of locating board with controller fails to work. C. Control board is faulty.		A. Replace the locating board. B. Replace the wiring of locating board. C. Replace the control board.
6. E3 or E4 flash	A. Control board is faulty.		A. Replace the control board.
7. E5 flash	Regeneration water is unqualified twice sequentially.	A. Resin invalid B. Acid and alkaline drawing tube is plugged. C. Acid-alkaline trough lacks acid and alkaline. Resistivity meter is faulty.	A. Replace the resin B. Check the acid and alkaline drawing tube C. Refill acid and alkaline Check and fix the resistivity meter.

MODEL:15702, 15704

3.8. Assembly & Parts

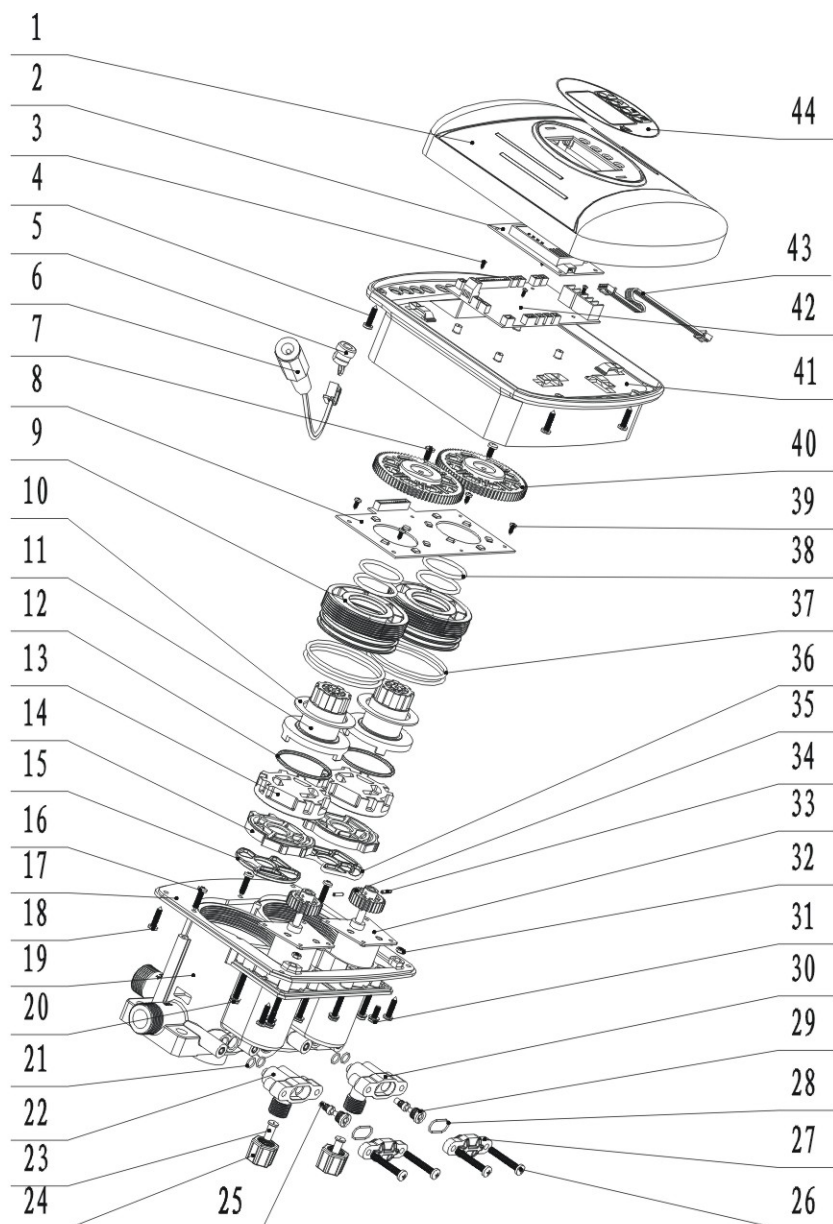

MODEL:15702, 15704

15702 Valve Body Components

Item number	Description	Part Number	Quantity	Remark
1	Front Cover	8300003	1	
2	Display Board	6381015	1	
3	Screw, Cross	8909004	4	
4	Screw, Cross	8909016	4	
5	Cable Clip	8126004	12	
6	Wire for Power	5513001	1	
7	Screw, Cross	8909013	2	
8	Locating Board	6380020	1	
9	Fitting Nut	8092011	2	
10	Anti-friction Washer	8216011	2	
11	Shaft	8258013	2	
12	Moving Seal Ring	8370064	2	
13	Moving Disk	8459007	2	
14	Fixed Disk	8469007	2	
15	Seal Ring	8370010	1	Red
16	Screw, Cross	8909016	3	
17	Joint Plate	8152004	1	
18	Screw, Cross	8909016	4	
19	Valve Body	5022003	1	
20	Screws, Cross	8902008	8	
21	O-ring	8378147	4	

MODEL:15702, 15704

22	Injector Body	8008026	1	Remark: T
23	Tube	8457031	2	
24	Hexagonal Nut	8940001	2	
25	Throat, Injector	8467001 8467002	2	Injector: 6301 6302
26	Screws, Cross	8902017	4	
27	Cover, Injector	8315003	2	
28	O-ring	8378148	2	
29	Nozzle, Injector	8454001 8454002	2	Injector: 6301 6302
30	Injector Body	8008027	1	Remark: B
31	Screws, Cross	8902005	2	
32	1 Type Hexagonal Nut	8940002	2	
33	Motor	6158011	2	
34	Pin	8993003	2	
35	Small Gear, Motor	8241006	2	
36	Seal Ring	8370011	1	Blue
37	O-ring	8378150	4	
38	O-ring	8378149	4	
39	Screw, Cross	8909007	4	
40	Big Gear, Driven	8241005	2	
41	Dust Cover	8005003	1	
42	Control Board	8382040	1	
43	Wire for Display Board	5512001	1	
44	Label	8865003	1	

MODEL:15702, 15704

15704 Valve Body Components

Item number	Description	Part Number	Quantity	Remark
1	Front Cover	8300003	1	
2	Display Board	6381015	1	
3	Screw, Cross	8909004	4	
4	Screw, Cross	8909016	4	
5	Cable Clip	8126004	12	
6	Wire for Power	5513001	1	
7	Screw, Cross	8909013	2	
8	Locating Board	6380005	1	
9	Fitting Nut	8092012	2	
10	Anti-friction Washer	8216012	2	
11	Shaft	8258011	2	
12	Moving Seal Ring	8370001	2	
13	Moving Disk	8459049	2	
14	Fixed Disk	8469046	2	
15	Seal Ring	8370073	1	Red
16	Screw, Cross	8909016	3	
17	Screw, Cross	8909016	4	
18	Valve Body	5022044	1	
19	Screws, Cross	8902008	8	
20	O-ring	8378147	4	
21	Injector Body	8008026	1	Remark: T

MODEL:15702, 15704

22	Tube	8457031	2	
23	Hexagonal Nut	8940001	2	
24	Throat, Injector	8467004 8467005	2	Injector: 6304 6305
25	Screws, Cross	8902017	4	
26	Cover, Injector	8315003	2	
27	O-ring	8378148	2	
28	Nozzle, Injector	8454004 8454005	2	Injector: 6304 6305
29	Injector Body	8008027	1	Remark: B
30	Screws, Cross	8902005	2	
31	Joint Plate	8152015	1	
32	1 Type Hexagonal Nut	8940002	2	
33	Motor	6158011	2	
34	Pin	8993003	2	
35	Small Gear, Motor	8241012	2	
36	Seal Ring	8370074	1	Blue
37	O-ring	8378102	4	
38	O-ring	8378123	4	
39	Screw, Cross	8909007	4	
40	Big Gear, Driven	8241013	2	
41	Dust Cover	8005030	1	
42	Control Board	8382040	1	
43	Wire for Display Board	5512001	1	
44	Label	8865003	1	

4. Warranty Card

Dear client:

This warranty card is the guarantee proof of RUNXIN brand multi-functional flow control valve. It is kept by client self. You could get the after-sales services from the supplier which is appointed by RUNXIN manufacturer. Please keep it properly. It couldn't be retrieved if lost.

It couldn't be repaired free of charge under the below conditions:

1. Guarantee period expired.(One year)
2. Damage resulting from using, maintenance, and keeping that are not in accordance with the instruction.
3. Damage resulting from repairing not by the appointed maintenance personnel.
4. Content in guarantee proof is unconfirmed with the label on the real good or be altered.
5. Damage resulting from force majeure.

Product Name	 Multi-functional Flow Control Valve for Water Treatment Systems			
Model			Code of Valve Body	
Purchase Company Name			Tel/Cel	
Problem				
Date of Repairing				
Solution		Date of Accomplishment		Maintenance Man Signature

When product need warranty service, please fill in the below content and send this card together with the product to the appointed suppliers or Runxin company.

End-user Company Name			Tel/Cel.	
Purchase Company Name			Tel/Cel.	
Model	Code of Valve Body			
Tank Size ϕ ×	Anion Resin Volume	L	Cation Resin volume	L
Inlet Water Conductivity US/cm	Backwash Time	M ³	Alkaline Drawing Time	Min
Acid-Alkaline Drawing Time Min	Acid-Alkaline Rinse Time	Min	Fast Rinse Time	Min
Problem Description				



WENZHOU RUNXIN MANUFACTURING MACHINE CO.,LTD

ADD: Jinger Road, Shatou Group, Linjiang, Lucheng District, Wenzhou, Zhejiang, China

TEL: 0577-88635628 88576511

FAX: 0577-88633258

Http://www.run-xin.com

Email:sales@run-xin.com